

FT-80C

SERVICE MANUAL

For Service Manuals Contact
MAURITRON TECHNICAL SERVICES
8 Cherry Tree Rd, Chinnor
Oxon OX9 4QY
Tel:- 01844-351694 Fax:- 01844-352554
Email:- enquiries@mauritron.co.uk

YAESU MUSEN CO., LTD.
C.P.O. BOX 1500
TOKYO, JAPAN

CONTENTS

TOP COVER REMOVAL.....	2
EXPLODED VIEW.....	3
MAIN UNIT.....	4
Parts Layout	4
Circuit Diagram	5
FILTER UNIT.....	7
Parts Layout	7
Circuit Diagram	7
NB UNIT.....	7
Parts Layout	7
Circuit Diagram	7
LOCAL UNIT.....	8
Parts Layout	8
Circuit Diagram	9
100W PA UNIT.....	10
Parts Layout	10
Circuit Diagram	10
LPF UNIT.....	11
Parts Layout	11
Circuit Diagram	11
DISPLAY UNIT.....	12
Parts Layout	12
Circuit Diagram	13
CONNECTION DIAGRAM.....	14
LEVEL DIAGRAM.....	15
Transmit	15
Receive	16
FM UNIT (Option).....	17
Parts Layout	17
Circuit Diagram	17
SIGNAL PATH.....	19
SSB MODE	19
CW MODE	20
AM MODE	21
FM MODE	22
CIRCUIT DESCRIPTION.....	23
PROGRAMMING.....	27
ALIGNMENT.....	29
I. Local Unit	31
II. Main Unit -- Receiver	32
III. Main Unit -- Transmitter	34
IV. Noise Blanker Unit	35
V. 100W PA Unit (Idling Current)	35
VI. LPF Unit (CM Coupler Balance)	36
VII. Main Unit (AFP - Automatic Final Protection)	36
PARTS LIST.....	37

FT-80C SERVICE MANUAL

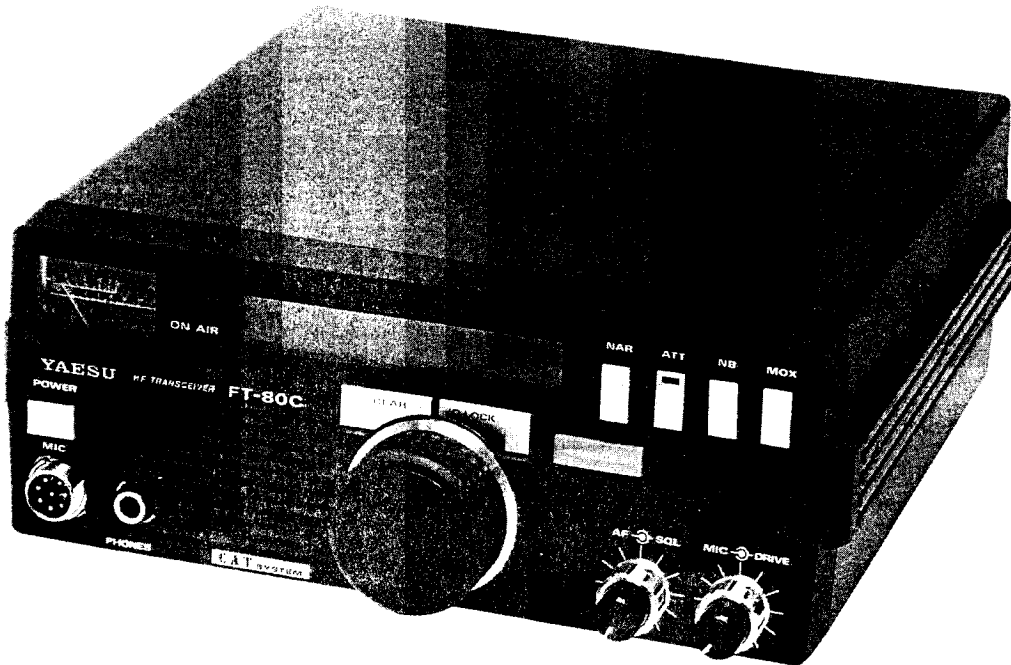

For Service Manuals Contact
MAURITRON TECHNICAL SERVICES
8 Cherry Tree Rd, Chinnor
Oxon OX9 4QY
Tel: 01844-351694 Fax: 01844-352554
Email: enquiries@mauritron.co.uk

This manual provides the technical information necessary for trained technicians to service the FT-80C, when used in conjunction with the FT-80C Operating Manual. Detailed information regarding functions, interconnections and operation has been provided in the Operating Manual, and is not reprinted herein.

General information on integrated circuits and their applications is available in the data provided by the IC manufacturers. Specific circuit details are provided in the schematic diagrams in this manual. Yaesu recommends that all service jobs be performed only by qualified radio technicians having all necessary test equipment, and thorough familiarity with its use.

While we believe the technical information in this manual is correct, Yaesu assumes no liability for damage that may occur as a result of typographical or other errors that may be present. Your cooperation in pointing out any inconsistencies in the technical information would be appreciated.

Yaesu Musen reserves the right to make changes in the circuitry of this transceiver, in the interest of technological improvement, without obligation to notify owners or to modify any sets produced prior to the modification. Notwithstanding, Yaesu may issue addenda to this manual from time to time, which will be made available through Yaesu distributors.

TOP COVER REMOVAL

To open the case of the FT-80C, remove the eight screws indicated in Figure 1. Then with the transceiver facing away from you, grasp the top panel with both hands near the front as shown in Figure 2. There are clips at positions **A** which can move only vertically, and a clip at **B** which can move only horizontally. Lift up on both sides to unlatch the clips at points **A** while holding the center clip **B** in the same position with your thumbs, and then slide the top panel back about 2 centimeters (1 inch) until the clips clear the top edge of the front panel.

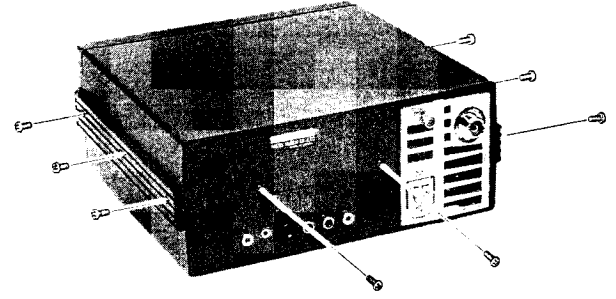

Figure 1

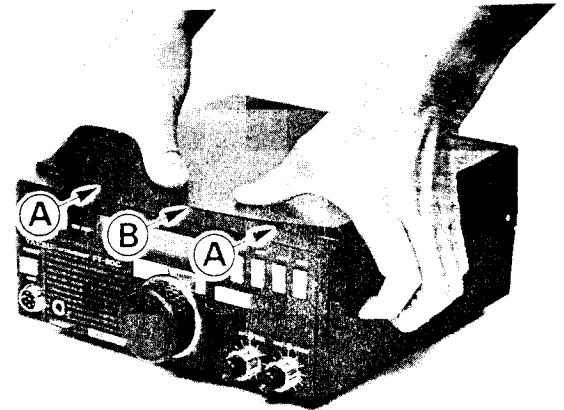

Figure 2

For Service Manuals Contact
MAURITRON TECHNICAL SERVICES
8 Cherry Tree Rd, Chinnor
Oxon OX9 4QY
Tel:- 01844-351694 Fax:- 01844-352554
Email:- enquiries@mauritron.co.uk

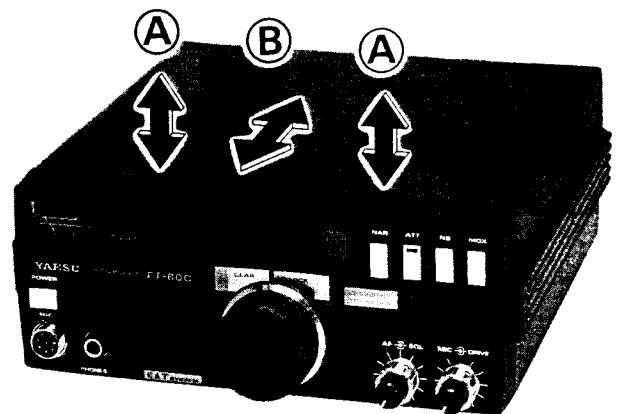
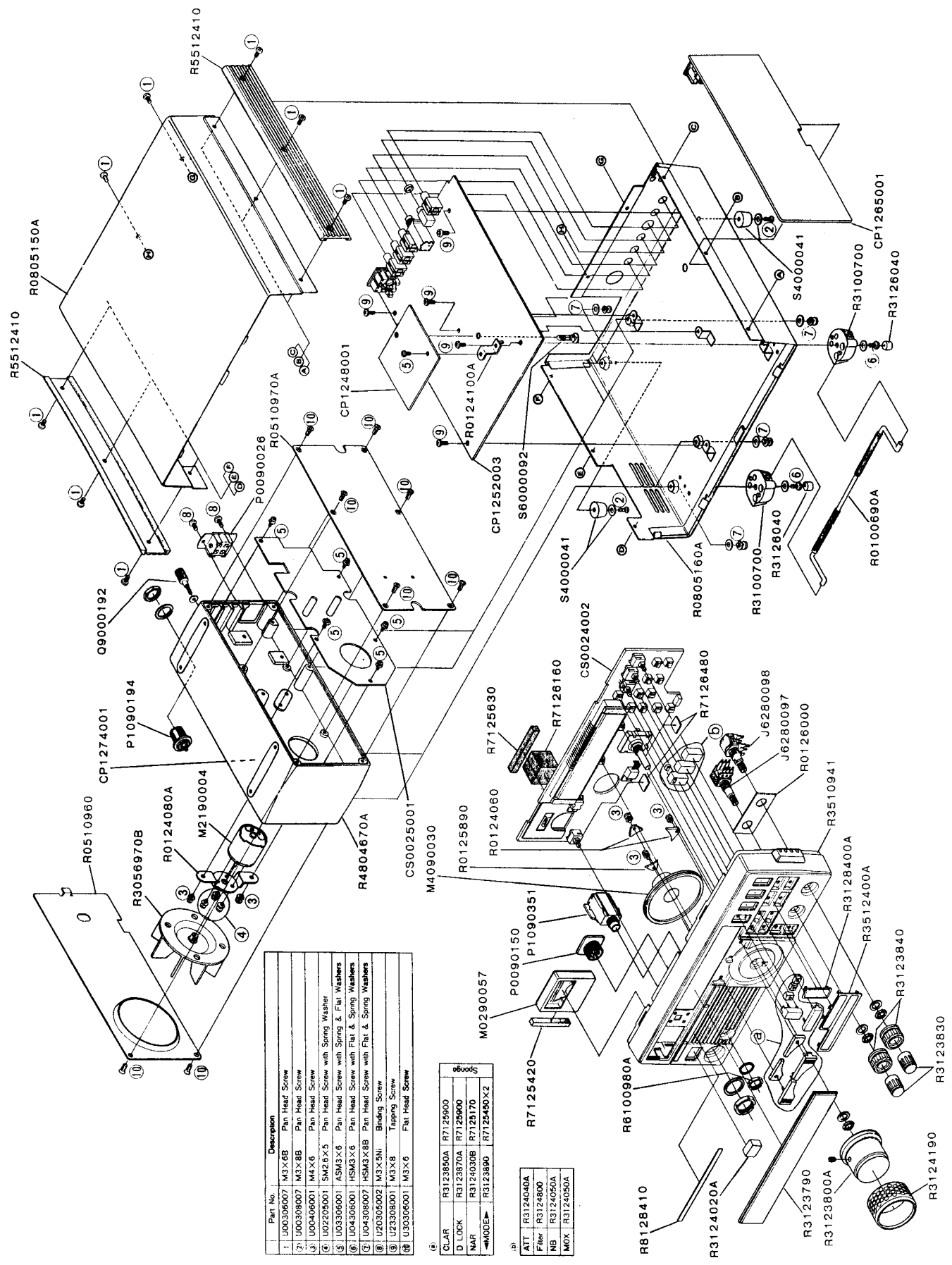

Figure 3

EXPLODED VIEW



Part No.	Description
1	U00308007 M3X6B Pan Head Screw
2	U00308007 M3X8B Pan Head Screw
3	U00406001 M4X6 Pan Head Screw
4	U02295001 SM26X5 Pan Head Screw with Spring Washers
5	U00308001 ASM3X6 Pan Head Screw with Spring & Flat Washers
6	U04308007 HSM3X6 Pan Head Screw with Spring & Flat Washers
7	U04308007 HSM3X8B Pan Head Screw with Flat & Spring Washers
8	U20306002 M3X5NI Binding Screw
9	U23308001 M3X8 Tapping Screw
10	U30306001 M3X6 Flat Head Screw

(a)	CLAR	R3123850A	R7125900
	D LOCK	R3123870A	R7125900
	NAR	R3124050B	R7125170
	WVODE	R3123890	R7125490X2

(b)	ATT	R3124000A
	Filter	R3124800
	NB	R3124050A
	MOX	R3124050A

MAIN UNIT

For Service Manuals Contact
MAURITRON TECHNICAL SERVICES
 8 Cherry Tree Rd, Chinnor
 Oxon OX9 4QY
 Tel: 01844-351694 Fax: 01844-352554
 Email: enquiries@mauritron.co.uk

PARTS LAYOUT

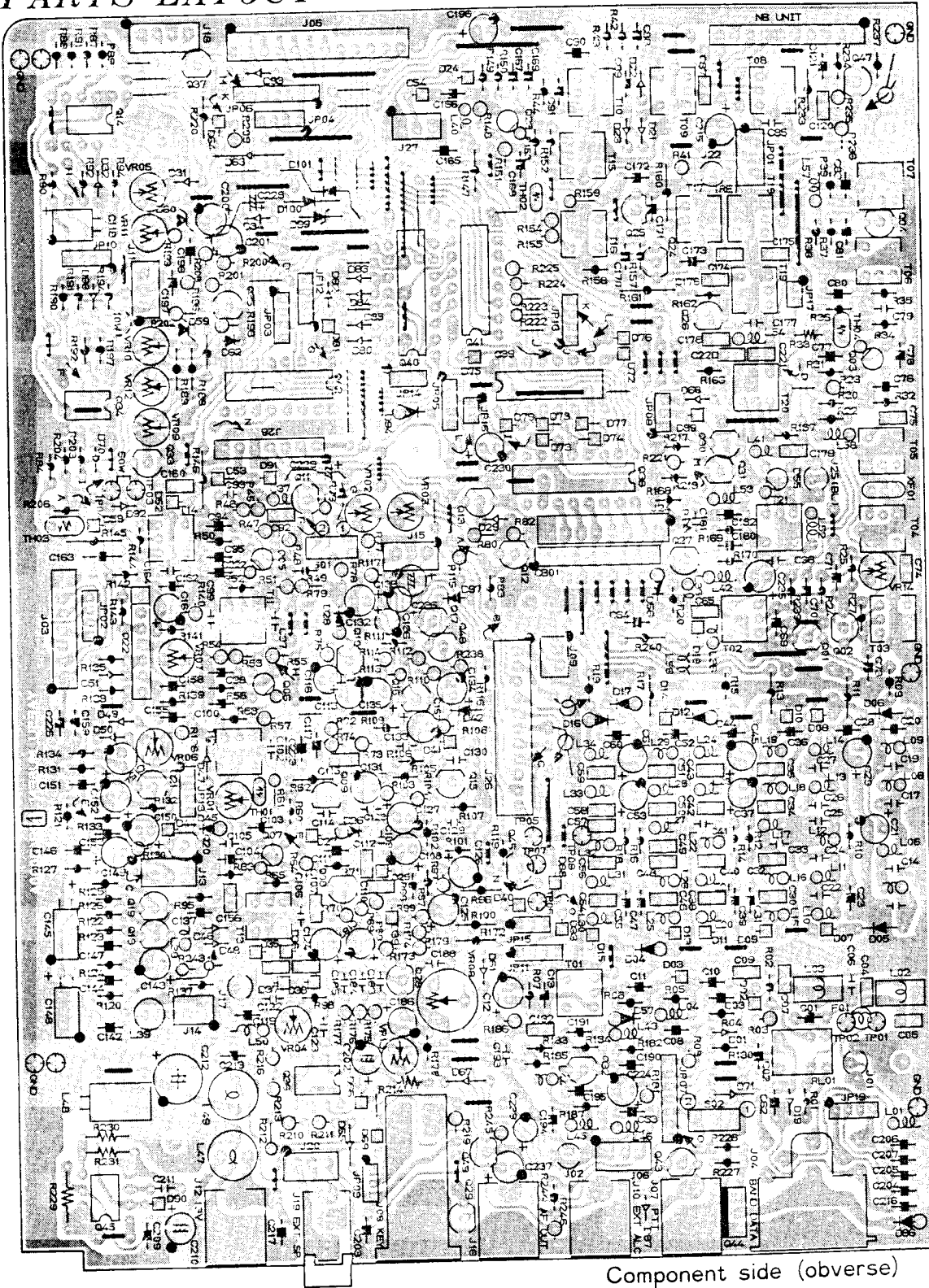

Component side (obverse)

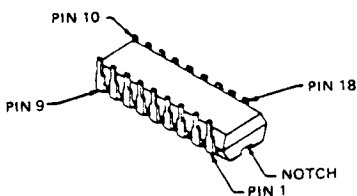
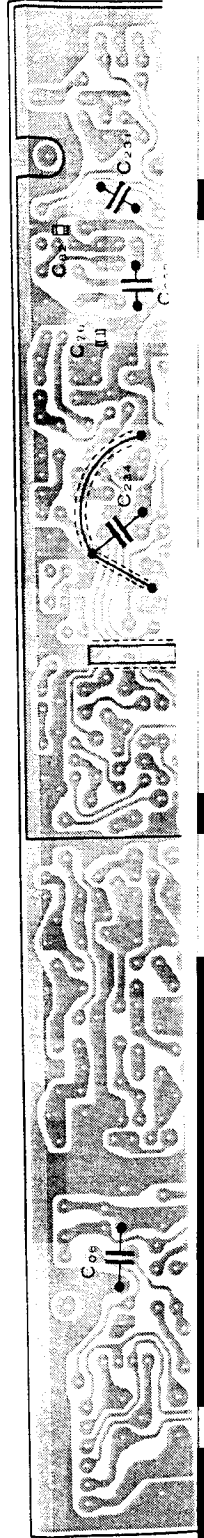

M54563P (Q1038)
 M54564P (Q1040)

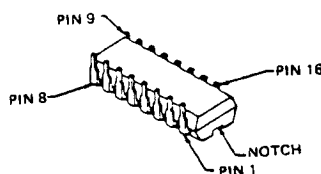

μPD4028BC (Q1039)
 μPD4094BC (Q1041, 1042)

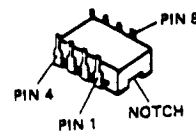

IR3M03A (Q1045)
 M5218P (Q1014, 1034)
 M5223P (Q1036)

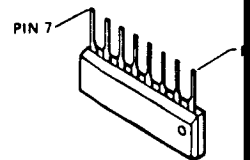

μPC1037H (Q1022)

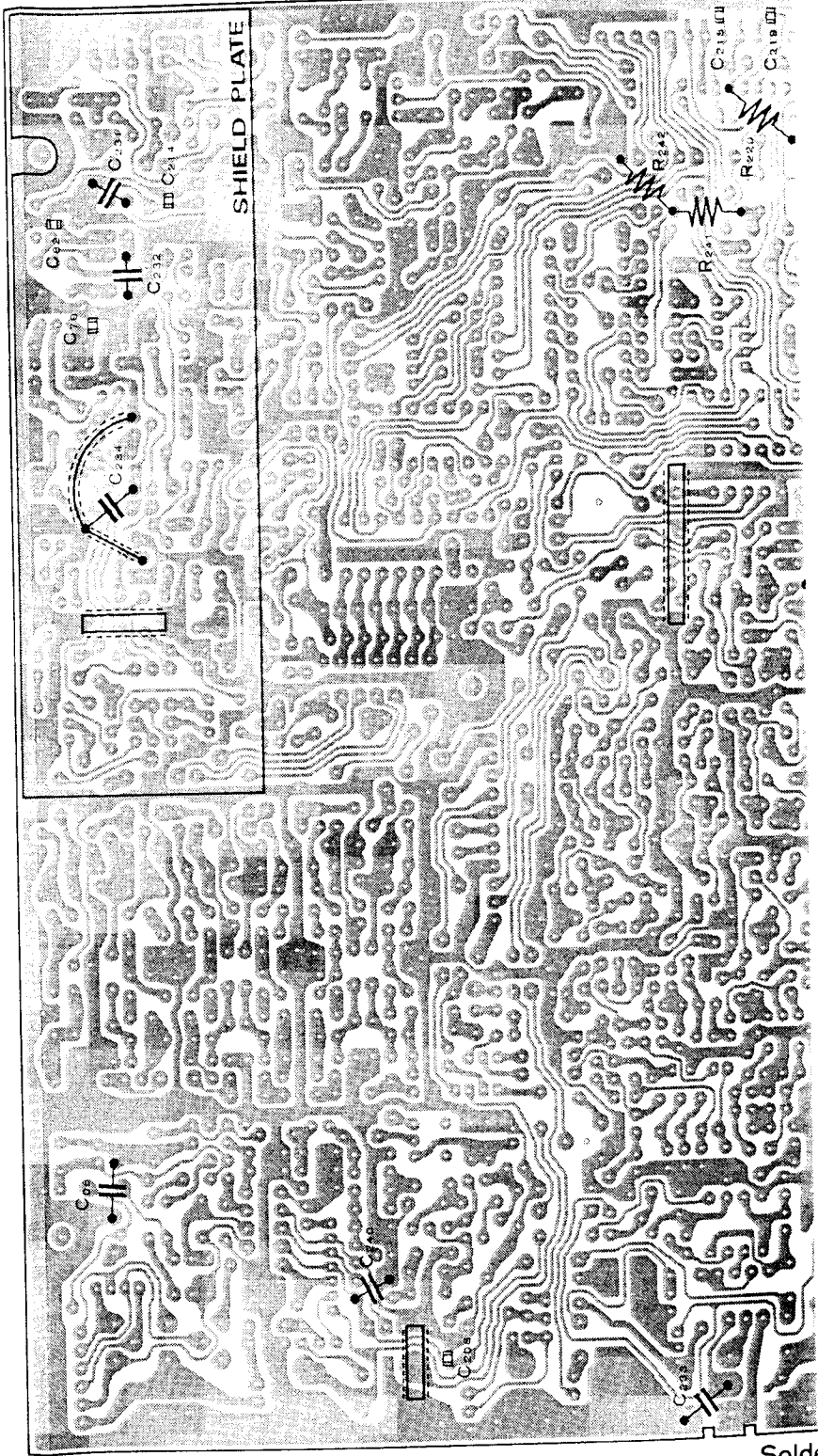
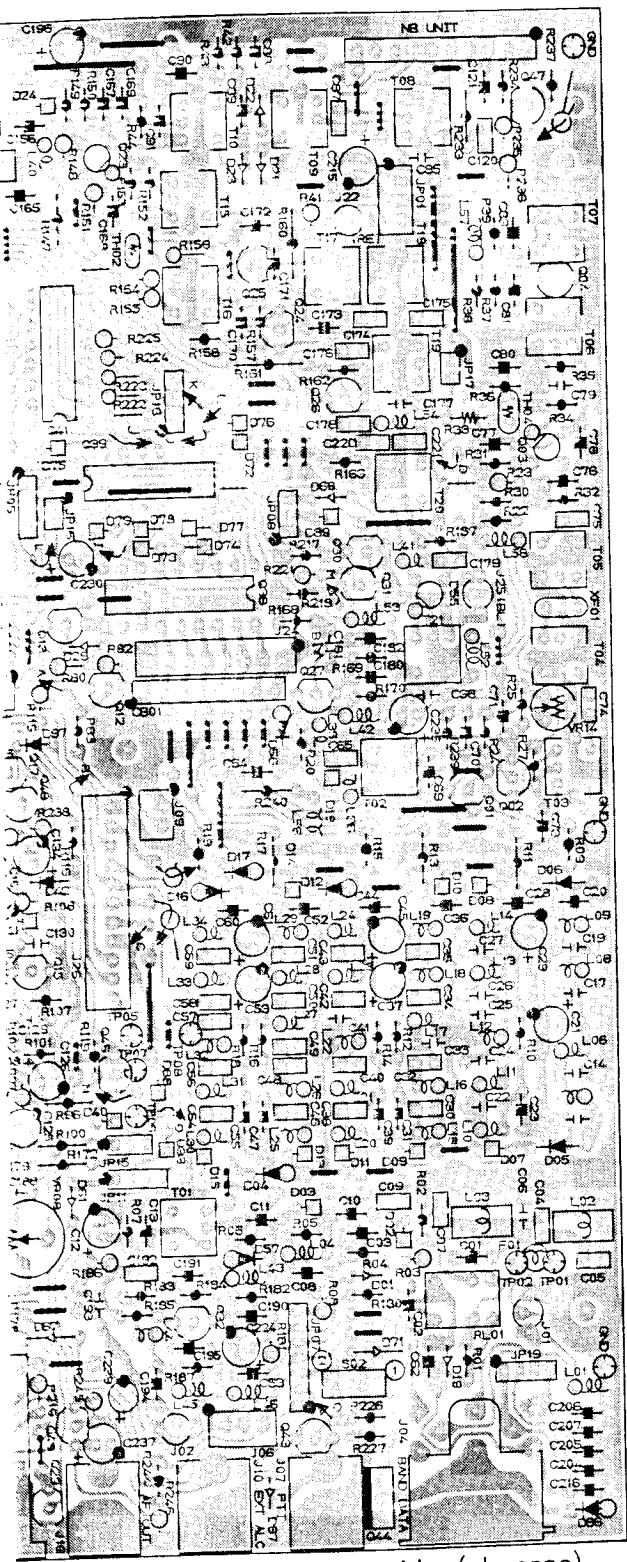

Sold

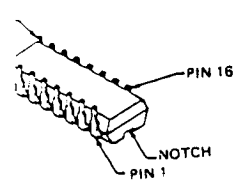

28BC (Q1039)
94BC (Q1041,1042)

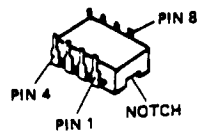

IR3M03A (Q1045)
M5218P (Q1014,1034)
M5223P (Q1036)

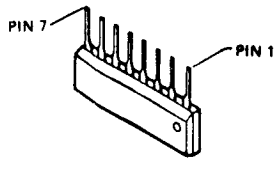

μPC1037H (Q1022)

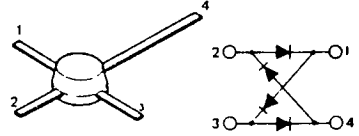

ND487C2-3R (D1055)

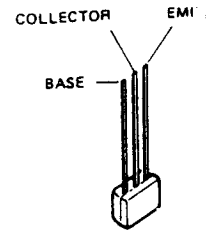

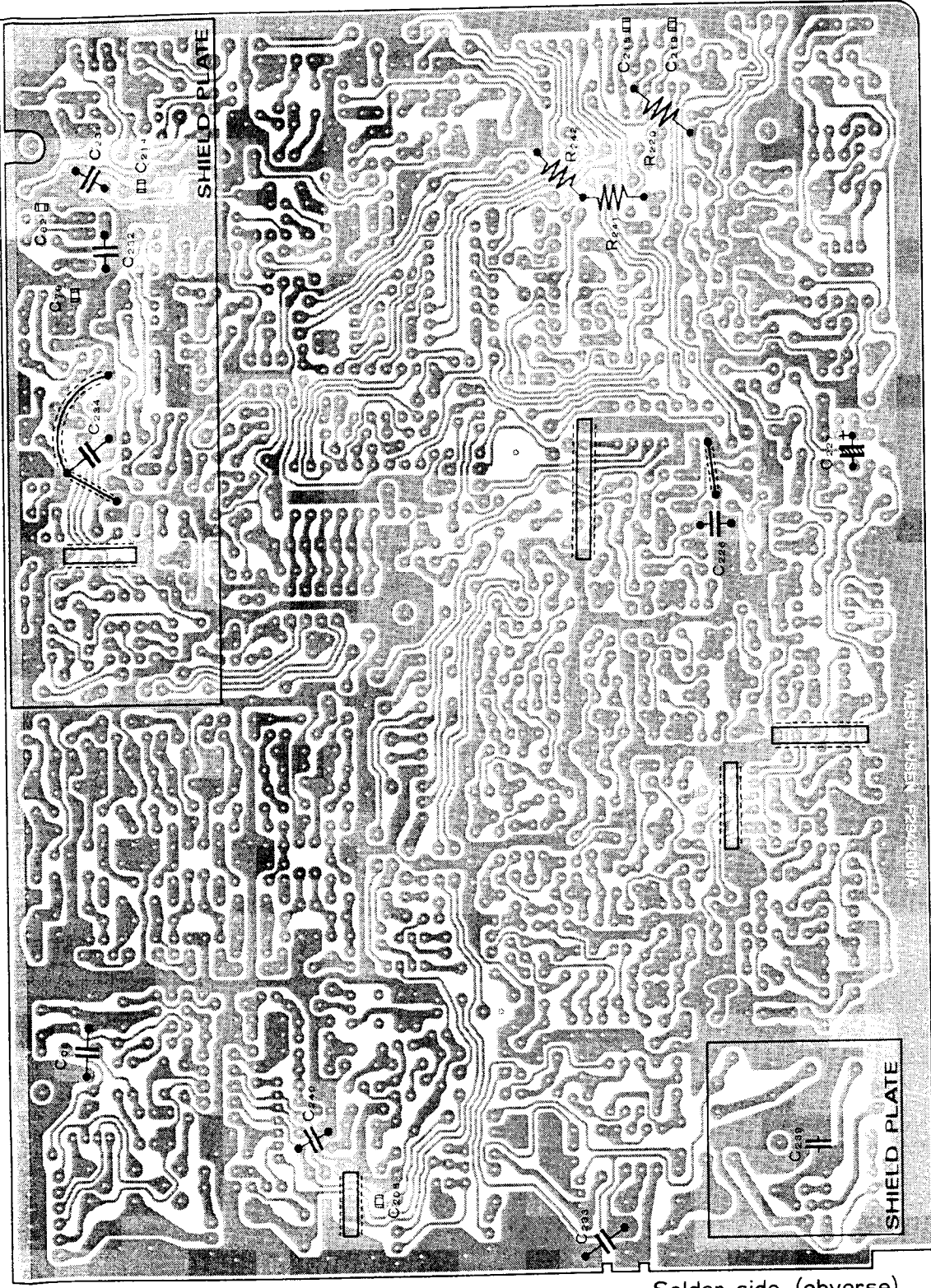

Solder side (obverse)

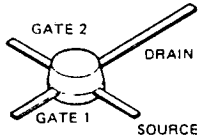

3SK74L (Q1003, 1005~1007, 1023)

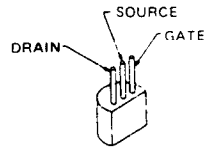

2SK104J (Q1010)

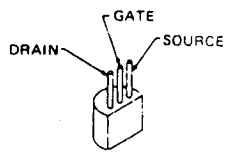

2SK125 (Q1001,1002, 1027)

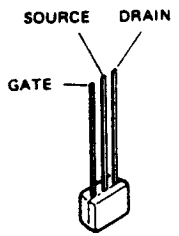

2SK192AGR (Q1011)
2SK241GR (Q1004,1024, 1025)

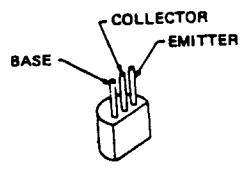

2SA733AP (Q1012)
2SC458B (Q1008,1009, 1015,1016, 1018,1019, 1021,1028, 1047,1049)

2SC458BTZ (Q1035)
2SC535B (Q1026)
2SC2053 (Q1032)

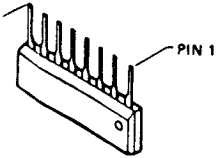

PC1037H (Q1022)

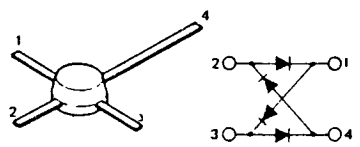

ND487C2-3R (D1055)

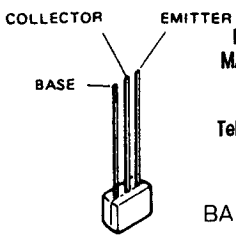

BA1A4M (Q1013,1020,1029,1030, 1033,1037,1046)

BA1L3Z (Q1017,1048)
DTA143ES (Q1031,1043)

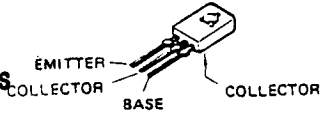

2SD669A (Q1044)

For Service Manuals Contact
MAURITRON TECHNICAL SERVICES
8 Cherry Tree Rd, Chinnor
Oxon OX9 4QY
Tel: 01844-351694 Fax: 01844-352554
Email: enquiries@mauritron.co.uk

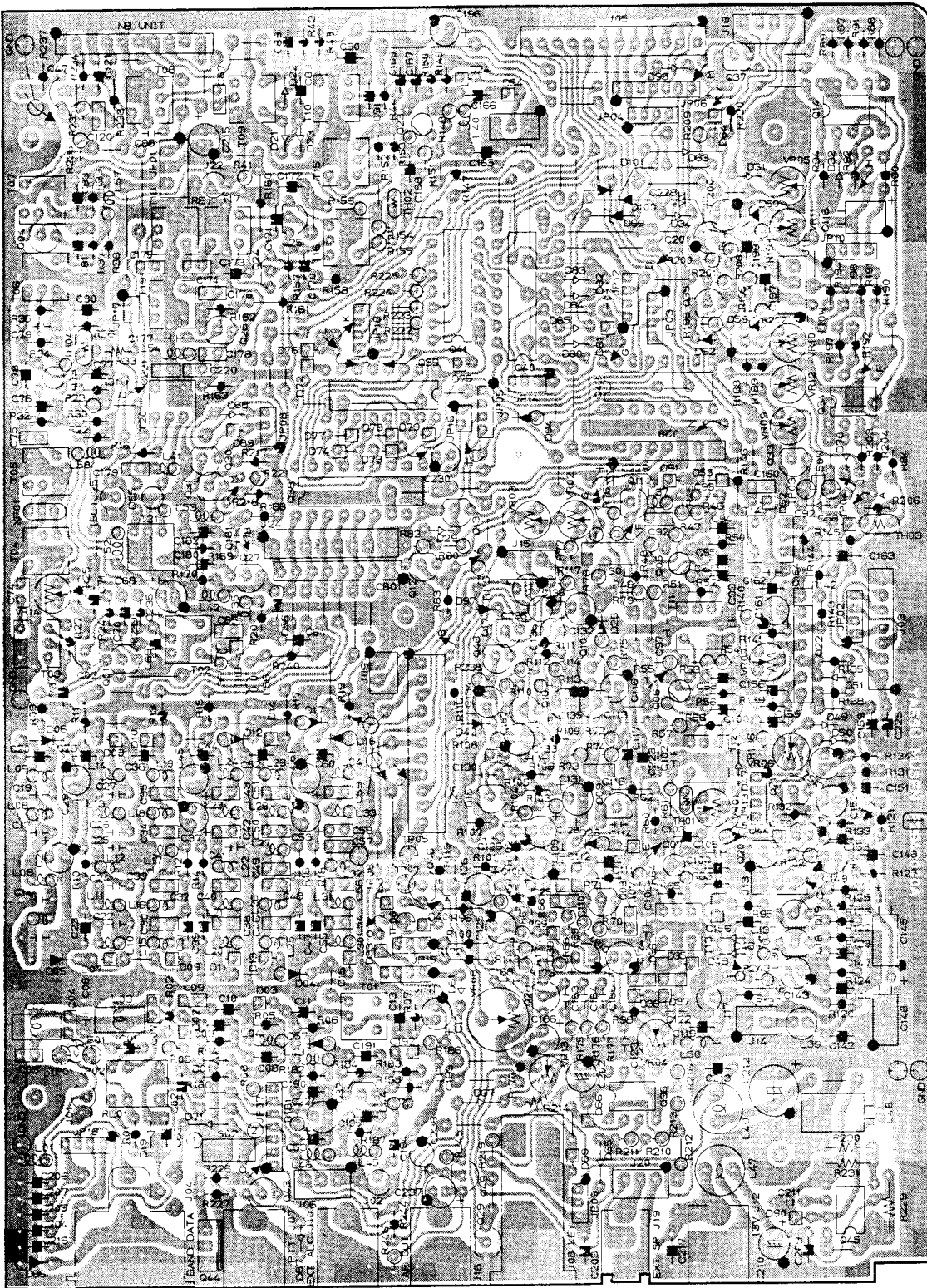

Component side (reverse)

	E (S)	C (D)
Q1001	25/-0.1	127/134
Q1002	25/-0.1	127/134
Q1003	2.0/0	132/134
Q1004	0.6	13.4
Q1005	1.7/0	7.8/8.8
Q1006	2.2	7.4
Q1007	1.9	8.0
Q1008	4.8	8.3
Q1009	0	3.4
Q1010	3.6	3.6
Q1011	6.2	8.8
Q1012	5.3/0.7	0/0
Q1013	0/0	5.0/0.1
Q1015	4.2	8.4
Q1016	1.3	4.4
Q1017	0/0	0/0
Q1018	0.1	1.4
Q1019	0.8	4.2
Q1020	0/0	0/0
Q1021	3.0	8.4
Q1023	1.9	0
Q1024	0/0.6	8.9/8.6
Q1025	0/0.6	8.9/8.6
Q1026	3.0	7.5
Q1027	0/1.6	-4.0/0.1
Q1028	0.6(0.3/0.6)	7.7(7.7/3.7)
Q1029	0(0/0)	0.6(0.6/0)
Q1030	0(0/0)	0(7.5/0)
Q1031	0(7.5/7.5)	0(-0.5/7.5)
Q1032	8.1	13.2
Q1033	0	6.9
Q1035	0	3.1
Q1037	0/0	0.5/7.4
Q1043	5.5/5.0	0/5.0
Q1044	0/0	0.6/0
Q1046	0/0	0.4/0
Q1047	0.8	8.7
Q1048	0/0	0/0

	1	2
Q1014	8.4/2.5	8.4/2
Q1022	7.0	-
Q1034	-5.2	0
Q1036	12.0/0.7	0/1.0
Q1038	0	0
Q1039	0	0
Q1040	0/0	4.8/2
Q1041	0	4.6
Q1042	0	0
Q1045	13.5	0.1

For Service Manuals
MAURITRON SERVICES
 8 Cherry Tree Road, Chinnor
 Oxfordshire, OX9 4QY.
 Tel (01844) 351694
 Fax (01844) 352554
 email:- mauritron@dial.pipex.com

4

MAIN UNIT VOLTAGE CHART

(DC VOLT)

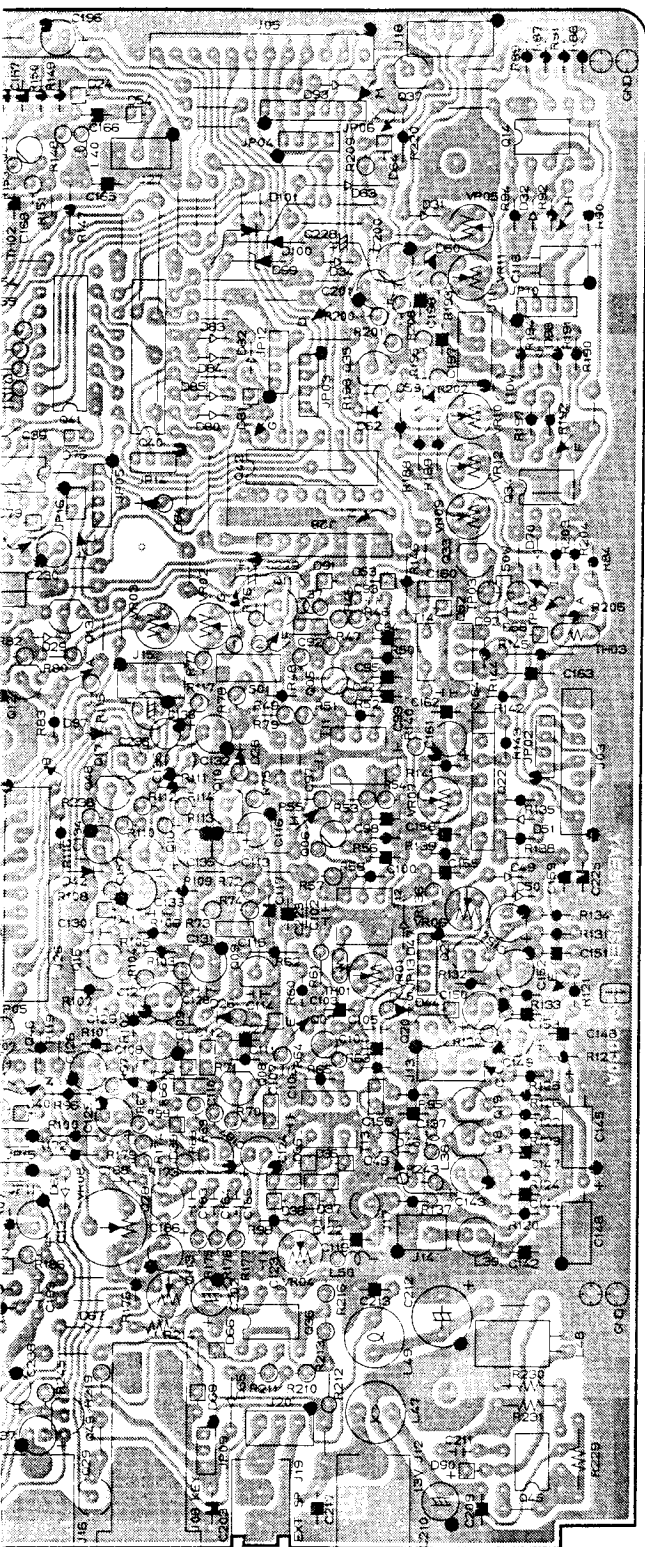

Component side (reverse)

	E (S)	C (D)	B (G ₁)	(G ₂)	REMARKS
Q1001	2.5/-0.1	12.7/13.4	-0.7/-5.1		RX/TX
Q1002	2.5/-0.1	12.7/13.4	-0.7/-5.1		RX/TX
Q1003	2.0/0	13.2/13.4	1.5/-4.1	3.2/3.2	RX/TX
Q1004	0.6	13.4	0		
Q1005	1.7/0	7.8/8.8	1.7/-4.0	3.4/3.4	RX/TX
Q1006	2.2	7.4	2.4	3.4	
Q1007	1.9	8.0	1.8	3.6	
Q1008	4.8	8.3	5.5		
Q1009	0	3.4	0.1		
Q1010	3.6	3.6	0		
Q1011	6.2	8.8	3.4		
Q1012	5.3/0.7	0/0	4.7/4.6		RX/TX
Q1013	0/0	5.0/0.1	0/4.3		RX/TX
Q1015	4.2	8.4	4.8		
Q1016	1.3	4.4	2.0		
Q1017	0/0	0/0	0.1/3.7		RX/TX
Q1018	0.1	1.4	0.7		
Q1019	0.8	4.2	1.4		
Q1020	0/0	0/0	7.0/0		RX/TX
Q1021	3.0	8.4	3.6		
Q1023	1.9	0	1.8	3.2	
Q1024	0/0.6	8.9/8.6	-3.9/0.1		RX/TX
Q1025	0/0.6	8.9/8.6	-3.9/0.1		RX/TX
Q1026	3.0	7.5	3.8		
Q1027	0/1.6	-4.0/0.1	0/6.9		RX/TX
Q1028	0.6(0.3/0.6)	7.7(7.7/3.7)	1.0(1.0/0.9)		RX CW(TX CW KEY UP/DWN)
Q1029	0(0/0)	0.6(0.6/0)	0(0/11.0)		RX CW(TX CW KEY UP/DWN)
Q1030	0(0/0)	0(7.5/0)	0(0/10.5)		RX CW(TX CW KEY UP/DWN)
Q1031	0(7.5/7.5)	0(-0.5/7.5)	0(7.5/0)		RX CW(TX CW KEY UP/DWN)
Q1032	8.1	13.2	8.8		
Q1033	0	6.9	0		
Q1035	0	3.1	-0.5		
Q1037	0/0	0.5/7.4	4.0/0		0.5-1.5, 14.5-18.5 / other 21.5-25.0MHz
Q1043	5.5/5.0	0/5.0	5.0/0.6		RX/TX
Q1044	0/0	0.6/0	0/0.6		RX/TX
Q1046	0/0	0.4/0	0/4.8		RX/TX (MODE FM) (SPLIT ON)
Q1047	0.8	8.7	1.5		
Q1048	0/0	0/0	0.1/3.7		RX/TX

MAIN UNIT IC VOI

	1	2	3	4	5	6	7	8	9	10
Q1014	8.4/2.5	8.4/2.5	8.8/2.5	-9.0/-9.0	3.1/2.7	7.0/1.8	-7.6/8.4	8.9/8.9		
Q1022	7.0	-	5.4	0	3.1	3.1	3.1			
Q1034	-5.2	0	0	-9.0	0	0	-7.7	8.9		
Q1036	12.0/0.7	0/10.2	4.2/3.9	0/0	4.2/3.9	12.9/2.1	0/10.8	13.1/12.3		
Q1038	0	0	0	4.1	0.2	0.2	0	0.1	13.4	0
Q1039	0	0	0	0	0	4.7	0	0	0	5.0
Q1040	0/0	4.8/4.8	0/0	0/0	0/0	0/0	0/4.4	4.5/0	8.9/8.9	0/0
Q1041	0	4.6	0	5.0	0	5.0	0	0	0	0
Q1042	0	0	0	4.8	0	0	0	0	0	0
Q1045	13.5	0.1	-8.2	-9.0	-7.8	13.5	13.5	13.5		

MAIN UNIT VOLTAGE CHART (DC VOLT)

(S)	C(D)	B(G ₁)	(G ₂)	REMARKS
1/-0.1	12.7/13.4	-0.7/-5.1		RX/TX
1/-0.1	12.7/13.4	-0.7/-5.1		RX/TX
0/0	13.2/13.4	1.5/-4.1	3.2/3.2	RX/TX
0.6	13.4	0		
7/0	7.8/8.8	1.7/-4.0	3.4/3.4	RX/TX
2.2	7.4	2.4	3.4	
1.9	8.0	1.8	3.6	
4.8	8.3	5.5		
0	3.4	0.1		
8.6	3.6	0		
5.2	8.8	3.4		
3/0.7	0/0	4.7/4.6		RX/TX
0/0	5.0/0.1	0/4.3		RX/TX
4.2	8.4	4.8		
1.3	4.4	2.0		
0/0	0/0	0.1/3.7		RX/TX
0.1	1.4	0.7		
0.8	4.2	1.4		
0/0	0/0	7.0/0		RX/TX
3.0	8.4	3.6		
1.9	0	1.8	3.2	
0/0.6	8.9/8.6	-3.9/0.1		RX/TX
0/0.6	8.9/8.6	-3.9/0.1		RX/TX
3.0	7.5	3.8		
1/1.6	-4.0/0.1	0/6.9		RX/TX
0.3/0.6	7.7(7.7/3.7)	1.0(1.0/0.9)		RX CW(TX CW KEY UP/DWN)
0/0	0.6(0.6/0)	0(0/11.0)		RX CW(TX CW KEY UP/DWN)
0/0	0(7.5/0)	0(0/10.5)		RX CW(TX CW KEY UP/DWN)
5/7.5	0(-0.5/7.5)	0(7.5/0)		RX CW(TX CW KEY UP/DWN)
3.1	13.2	8.8		
0	6.9	0		
0	3.1	-0.5		
0/0	0.5/7.4	4.0/0		05-15, 14.5-18.5 / other 21.5-23.0MHz
3/5.0	0/5.0	5.0/0.6		RX/TX
0/0	0.6/0	0/0.6		RX/TX
0/0	0.4/0	0/4.8		RX/TX (MODE FM SPLIT ON)
0.8	8.7	1.5		
0/0	0/0	0.1/3.7		RX/TX

For Service Manuals Contact
MAURITRON TECHNICAL SERVICES
 8 Cherry Tree Rd, Chinnor
 Oxon OX9 4QY
 Tel:- 01844-351694 Fax:- 01844-352554
 Email:- enquiries@mauritron.co.uk

MAIN UNIT IC VOLTAGE CHART

(DC VOLT)

1	2	3	4	5	6	7	8	9	10	11	12	13	14	15	16	17	18	REMARKS
8.4/2.5	8.4/2.5	8.8/2.5	-9.0/9.0	3.1/2.7	7.0/1.8	-7.6/8.4	8.9/8.9											SQL VR CCW/CW
7.0	-	5.4	0	3.1	3.1	3.1												
-5.2	0	0	-9.0	0	0	-7.7	8.9											
12.0/0.7	0/10.2	4.2/3.9	0/0	4.2/3.9	12.9/2.1	0/10.8	13.1/12.3											KEY UP/DWN (MODE CW VR13 MIN)
0	0	0	4.1	0.2	0.2	0	0.1	13.4	0	0.2	13.0	0	0	12.0	0	0	0	MODE AM, 14MHz
0	0	0	0	0	4.7	0	0	0	5.0	0	5.0	0	0	0	5.0			MODE AM, 14MHz
0/0	4.8/4.8	0/0	0/0	0/0	0/0	0/4.4	4.5/0	8.9/8.9	0/0	7.6/-1.3	0/7.5	0/0	0/0	0/0	7.7/7.7	7.9/7.9	0/0	MODE USB, RX/TX
0	4.6	0	5.0	0	5.0	0	0	0	0	0	0	0	4.8	5.0	5.0			14MHz
0	0	0	4.8	0	0	0	0	0	0	0	0	4.9	5.0	5.0	5.0			MODE USB, 14MHz
13.5	0.1	-8.2	-9.0	-7.8	13.5	13.5	13.5											

CIRCUIT DIAGRAM

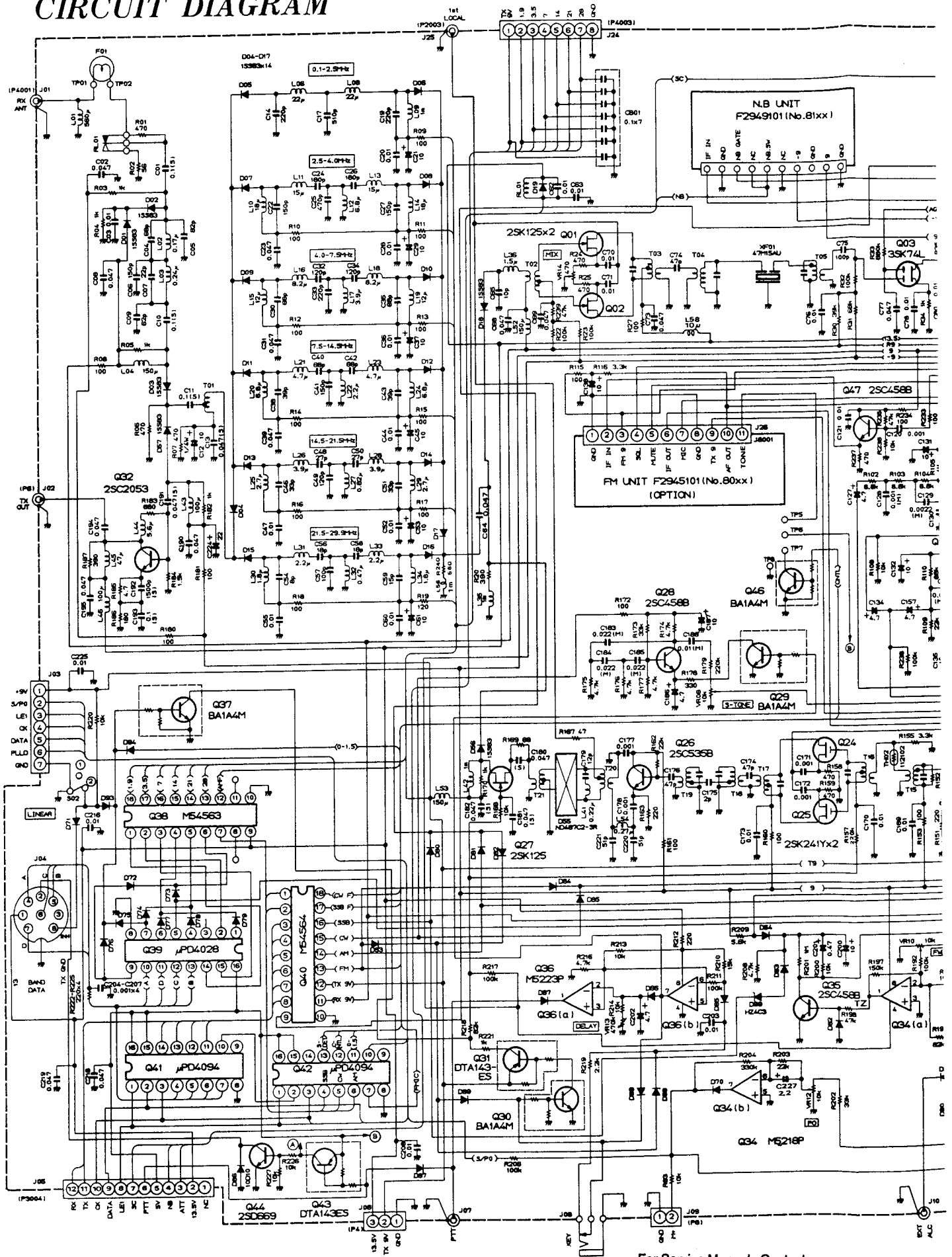

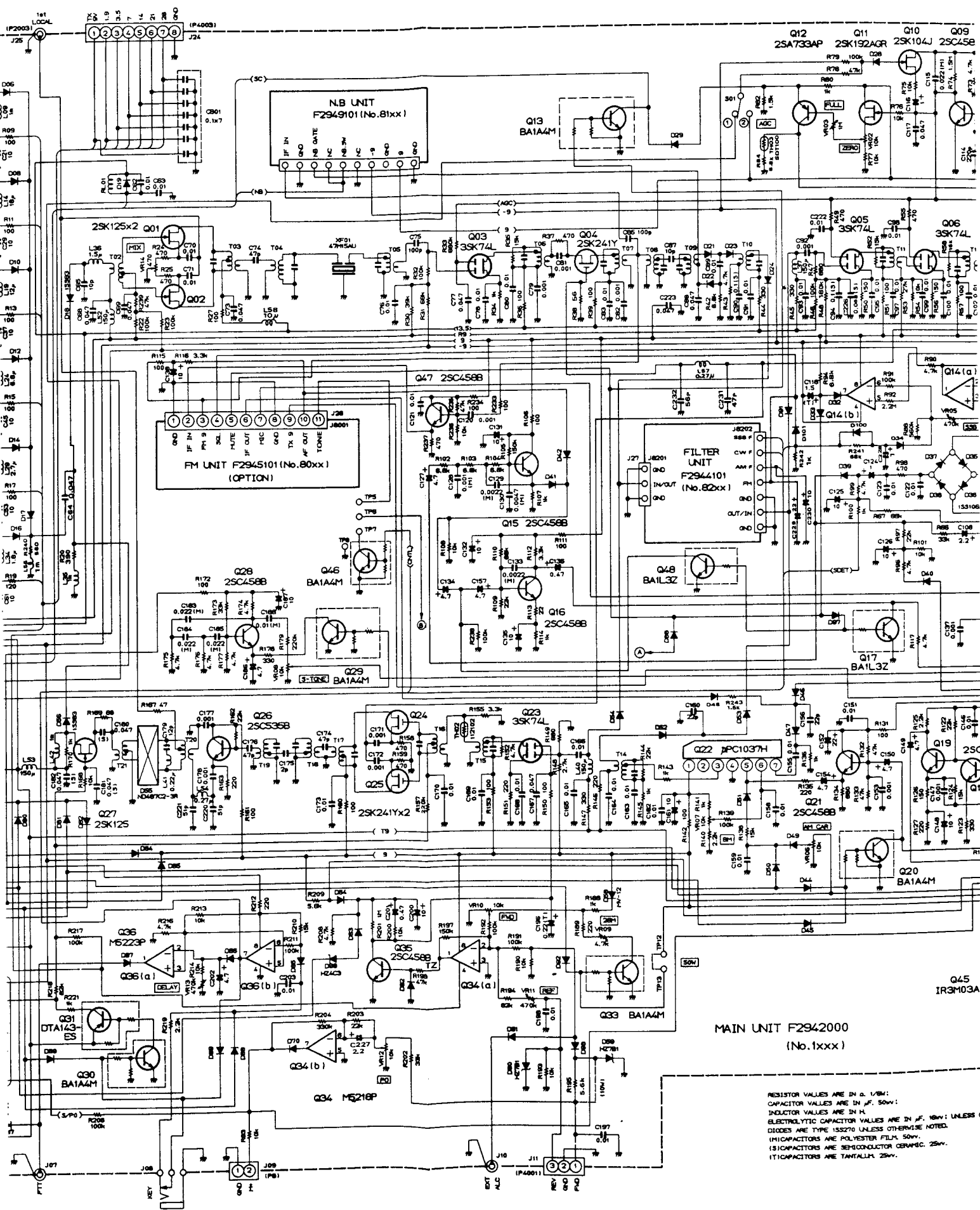

RESISTOR VALUES ARE IN Ω , $k\Omega$, $M\Omega$.
 CAPACITOR VALUES ARE IN μ , 50μ .
 INDUCTOR VALUES ARE IN μ .
 ELECTROLYTIC CAPACITOR VALUES ARE IN μ , $10m$, UNLESS OTHERWISE NOTED.
 DIODES ARE TYPE 1N5270 UNLESS OTHERWISE NOTED.
 (1) CAPACITORS ARE POLYESTER FILM, 50V.
 (2) CAPACITORS ARE SEMICONDUCTOR GRM/MC, 25V.
 (3) CAPACITORS ARE TANTALUM, 25V.

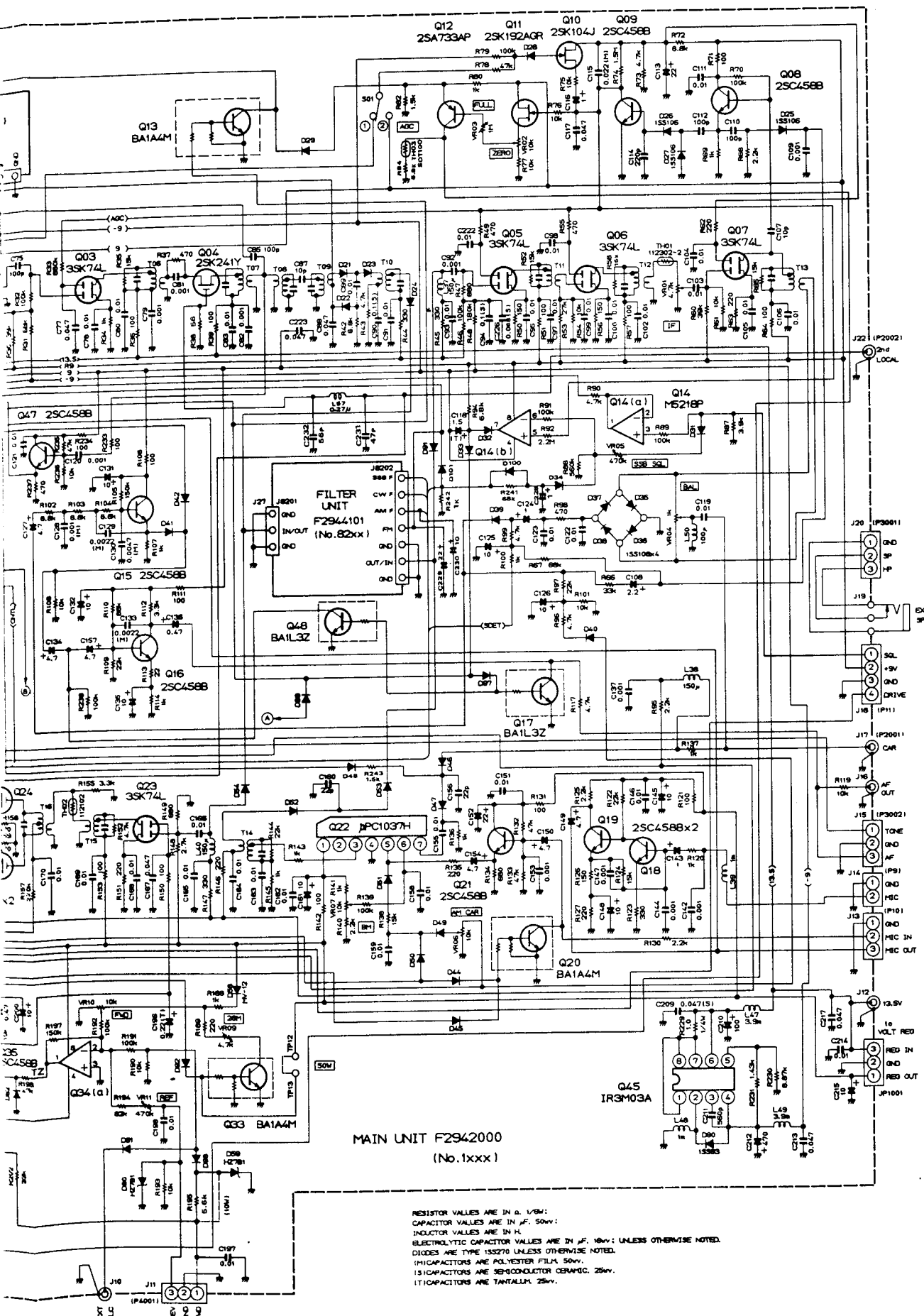

MAIN UNIT F2942000
(No. 1xxx)

RESISTOR VALUES ARE IN Ω, 1kΩ, 10kΩ, 100kΩ, 1MΩ;
 CAPACITOR VALUES ARE IN pF, 500V;
 INDUCTOR VALUES ARE IN μH;
 DIODES ARE TYPE 1N4148 UNLESS OTHERWISE NOTED.
 1N4148 CAPACITORS ARE POLYESTER FILM, 50V.
 1N4148 CAPACITORS ARE SEMICONDUCTOR CERAMIC, 25V.
 1N4148 CAPACITORS ARE TANTALUM, 25V.

FILTER UNIT PARTS LAYOUT

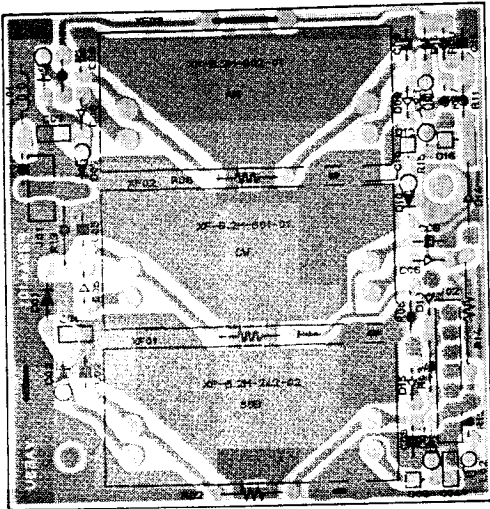

Component side (obverse)

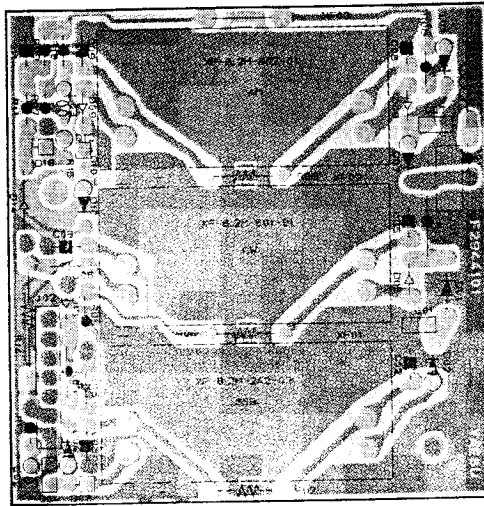

Component side (reverse)

FILTER UNIT CIRCUIT DIAGRAM

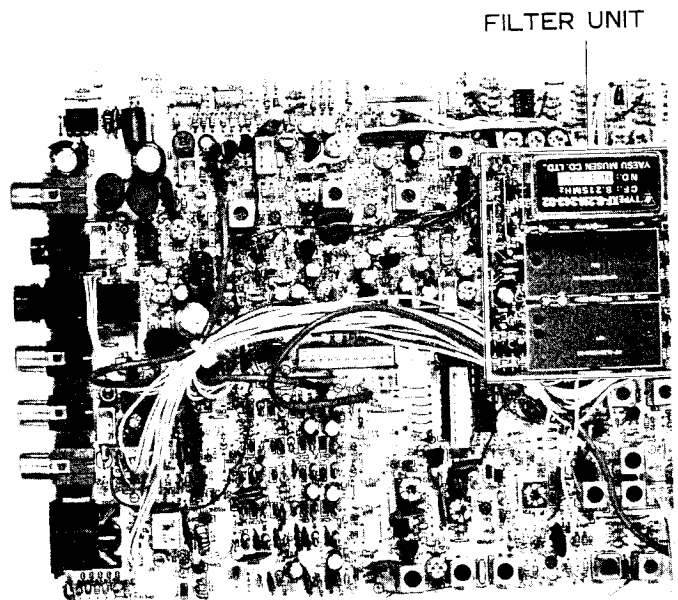
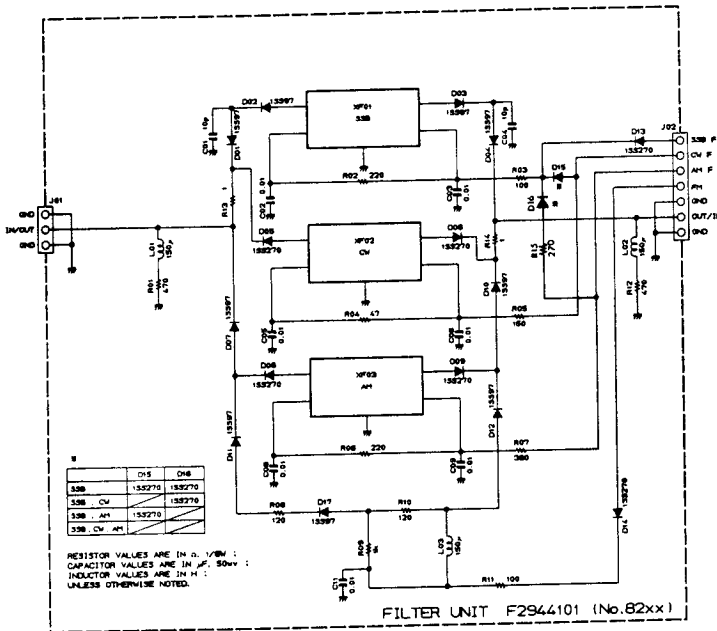

For Service Manuals Contact
MAURITRON TECHNICAL SERVICES
 8 Cherry Tree Rd, Chinnor
 Oxon OX9 4QY
 Tel: 01844-351694 Fax: 01844-352554
 Email: enquiries@mauritron.co.uk

PARTS LAYOUT

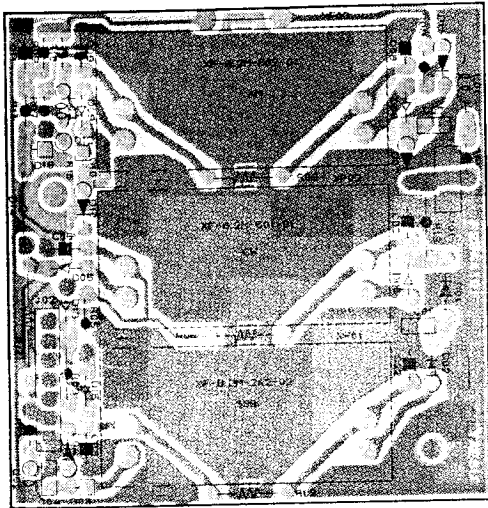
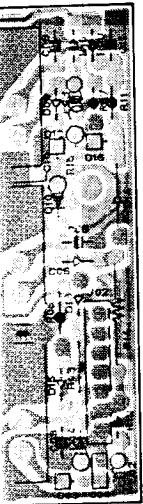

NB UNIT PAH

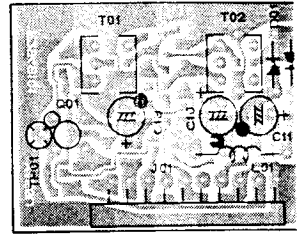

Component side (obverse)

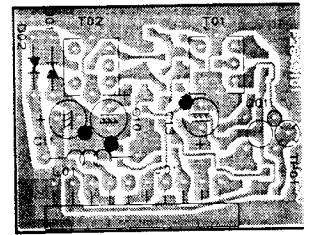

Component side (reverse)

CIRCUIT DIAGRAM

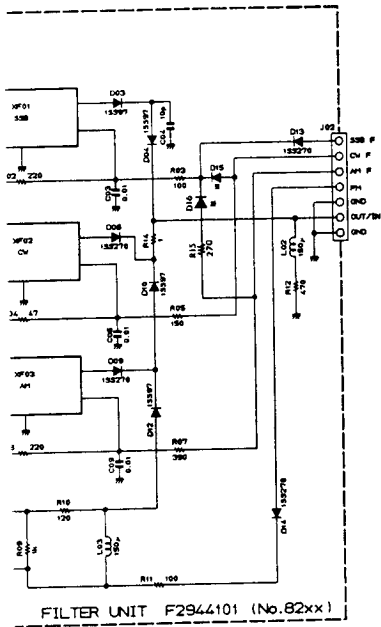

NB UNIT CIRCUIT

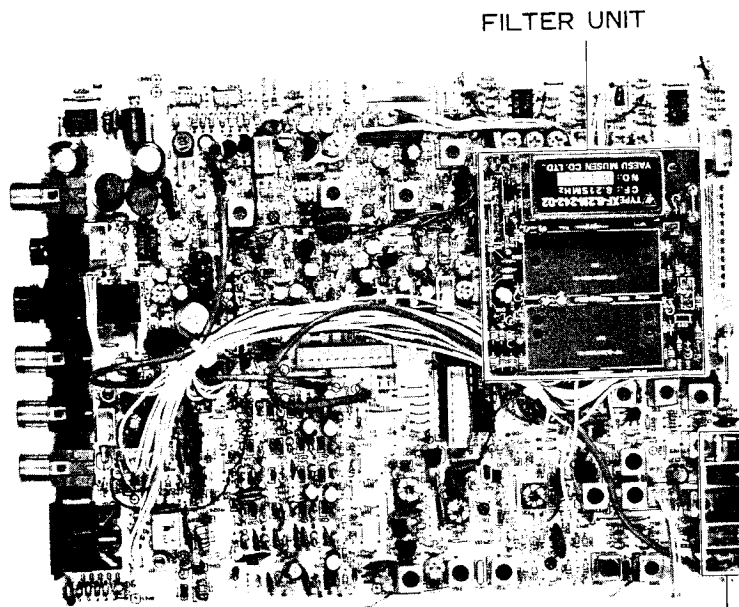
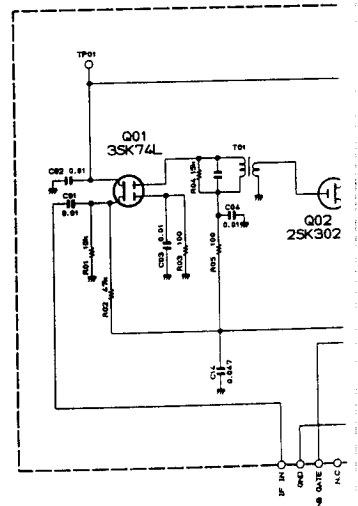

NB UNIT

NB UNIT VOLTAGE

	E(S)	C(D)	B(G ₁)
Q8101	7.4	1.5	1.5
Q8102	1.7/0	8.9/8.2	0/0
Q8103	-8.8	6.4	-8.9
Q8104	-9.1	4.3	-9.0

FILTER UNIT & NB UNIT

NB UNIT PARTS LAYOUT

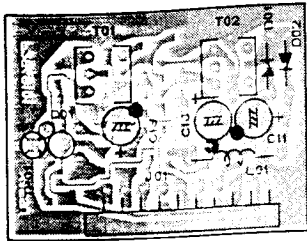

Component side (obverse)

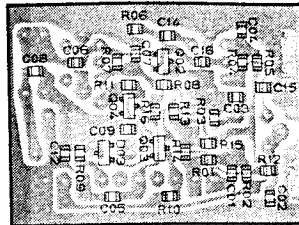

Solder side (obverse)

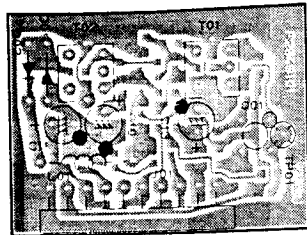

Component side (reverse)

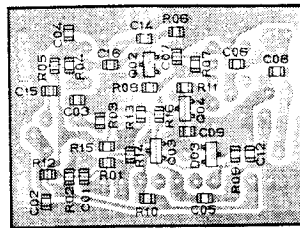

Solder side (reverse)

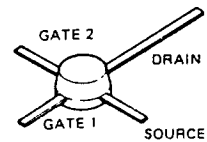

3SK74L
(Q8101)

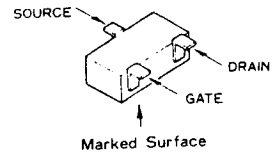

2SK302Y
(Q8102)

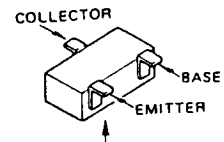

2SC3052F
(Q8103,8104)

NB UNIT CIRCUIT DIAGRAM

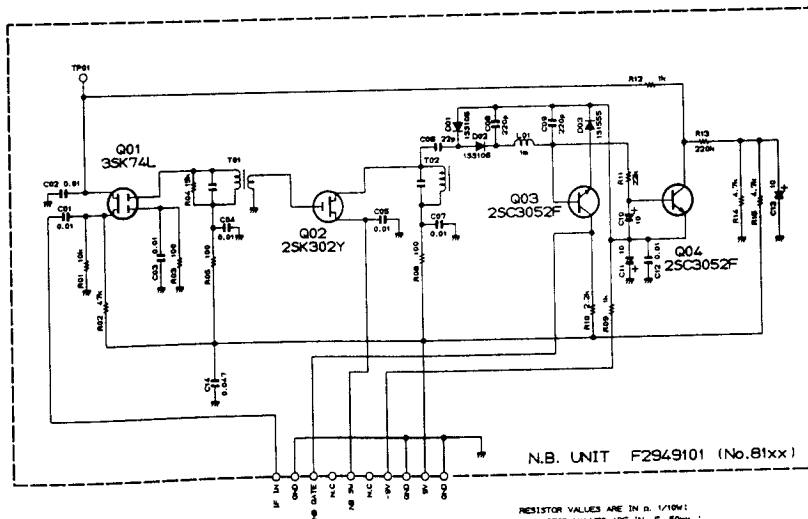

RESISTOR VALUES ARE IN Ω, 1/10W;
CAPACITOR VALUES ARE IN μF, 50V;
INDUCTOR VALUES ARE IN mH;
ELECTROLYTIC CAPACITOR VALUES ARE IN μF, 100V;
UNLESS OTHERWISE NOTED.

NB UNIT VOLTAGE CHART

(DC VOLT)

	E (S)	C (D)	B (G ₁)	(G ₂)	REMARKS
Q8101	7.4	1.5	1.5	4.3	
Q8102	1.7/0	8.9/8.2	0/0		NB OFF/ON
Q8103	-8.8	6.4	-8.9		
Q8104	-9.1	4.3	-9.0		

For Service Manuals Contact
MAURITRON TECHNICAL SERVICES
8 Cherry Tree Rd, Chinnor
Oxon OX9 4QY
Tel:- 01844-351694 Fax:- 01844-352554
Email:- enquiries@mauritron.co.uk

TER UNIT

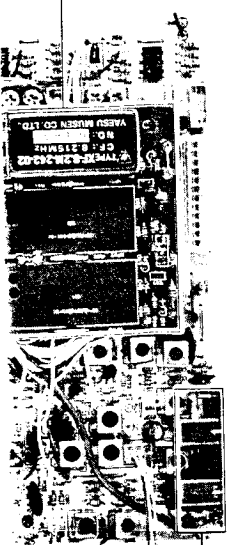

NB UNIT

PARTS LAYOUT

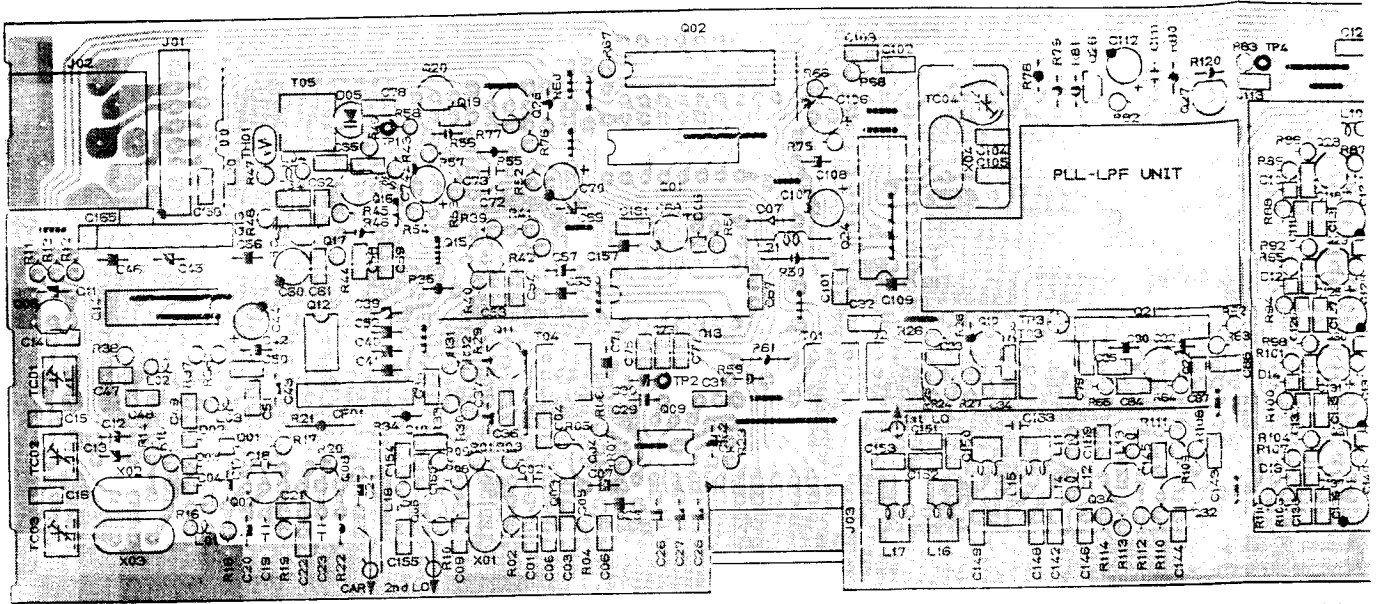

Component side

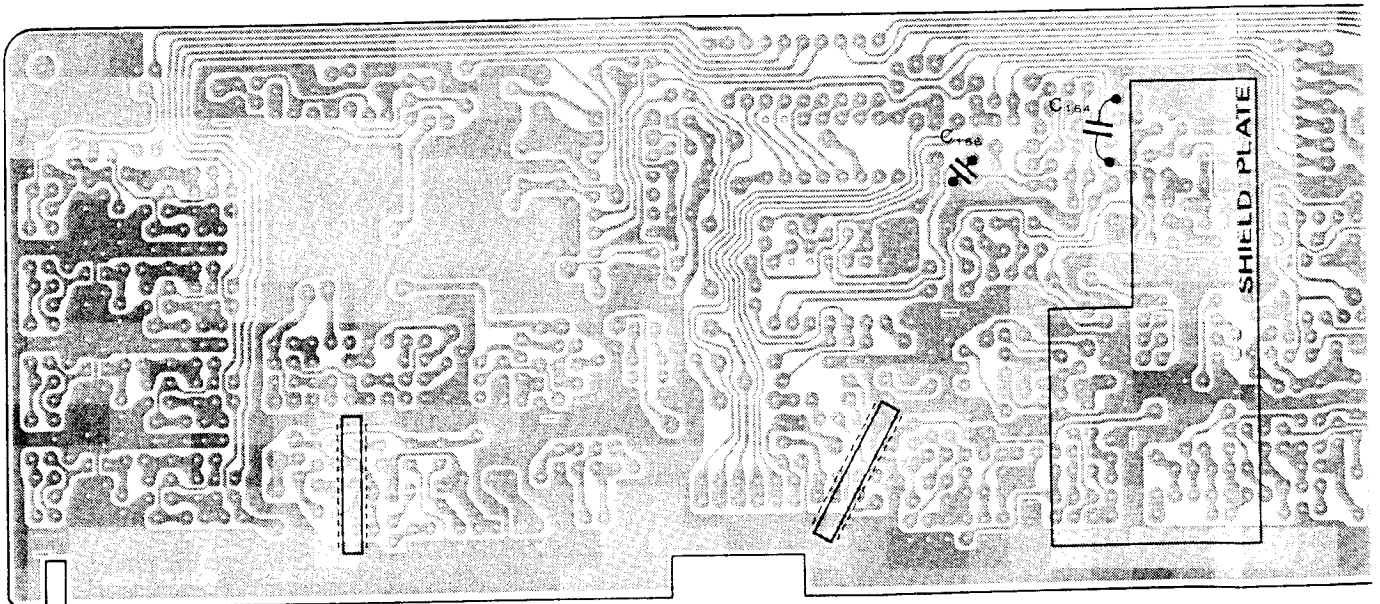

Solder side

For Service Manuals Contact
MAURITRON TECHNICAL SERVICES
 8 Cherry Tree Rd, Chinnor
 Oxon OX9 4QY
 Tel:- 01844-351894 Fax:- 01844-352554
 Email:- enquiries@mauritron.co.uk

LOCAL UNIT IC VOLTAGE CHART

	1	2	3	4	5	6	7	8	9	10	11	12	13	14	15	16	17
Q2001	-	-	-	0	4.8	0	0	0	0	0	0	4.8	0	0	5.0	5.0	
Q2002	0	0	4.8	0	0	4.8	0	0	8.8	0	0	0	7.6	0	0	7.6	-0.4
Q2009	6.4	3.8	2.7	0	2.7	3.8	3.8	7.8									
Q2012	6.4	3.8	2.7	0	2.7	3.8	3.8	7.7									
Q2013	0	0	4.9	2.6	2.6	0	4.9	2.5									
Q2014	0	4.9	0	0	0	0	0	0	2.5	0	2.5	2.5	2.3	4.9			
Q2018	-2.4	-	-	-	2.1	2.2	0.5	0	-	-	2.4	5.0	4.2	0			
Q2021	5.9	5.2	4.8	0	2.6	2.6	2.6										
Q2024	-2.4	-	-	-	2.2	1.9	0.5	0	-	-	0.5	4.8	2.0	0			

LOCAL UNIT VOLTAGE CHART (DC VOLT)

	E (S)	C (D)	B (G)	REMARKS
Q2003	3.1	8.1	3.9	
Q2004	3.5	8.1	4.2	
Q2005	1.4	8.1	2.2	
Q2006	0/0	0.7/0	0/0.7	RX/TX, MODE CW
Q2007	2.0	6.6	2.0	MODE USB
Q2008	1.7	8.0	2.4	MODE USB
Q2010	1.8	8.4	2.5	
Q2011	1.9	8.4	2.6	
Q2015	3.6	8.0	4.2	
Q2016	2.3	8.3	2.9	
Q2017	1.0	8.4	0	
Q2019	8.6	0.5	0.6	
Q2020	0	5.6	0.7	
Q2022	2.5	8.3	3.2	
Q2025	0/0	5.0/0	0/0.6	PLL LOCK/UNLOCK
Q2026	0.8	8.6	0.5	14MHz
Q2027	0.1	5.3	0.8	14MHz
Q2028	2.6	7.1	3.3	3.5MHz
Q2029	2.6	7.1	3.3	28MHz
Q2030	2.6	7.1	3.3	18MHz
Q2031	3.1	7.0	3.9	28MHz
Q2032	2.5	8.3	3.3	
Q2034	2.8	8.7	3.5	

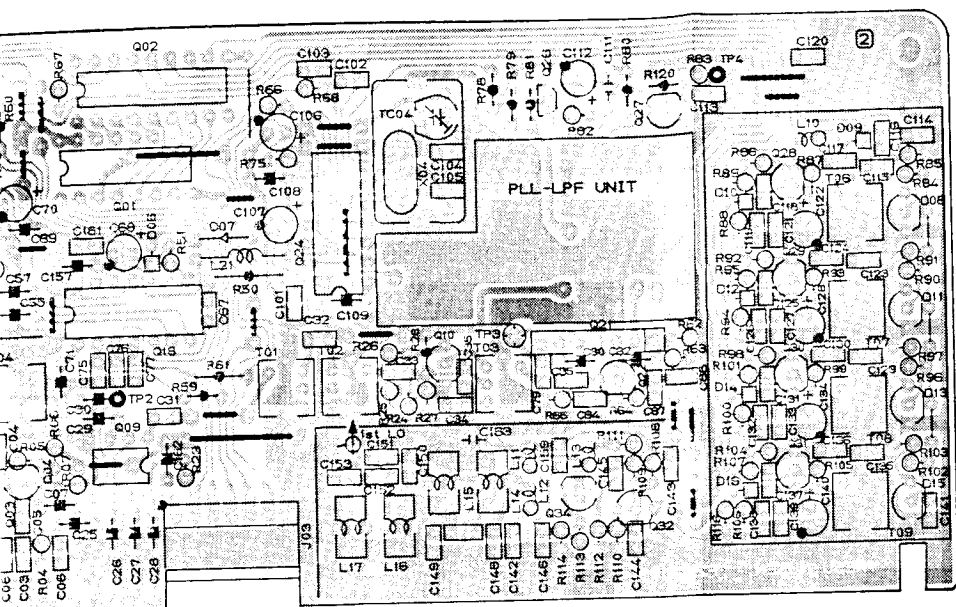

Component side (obverse)

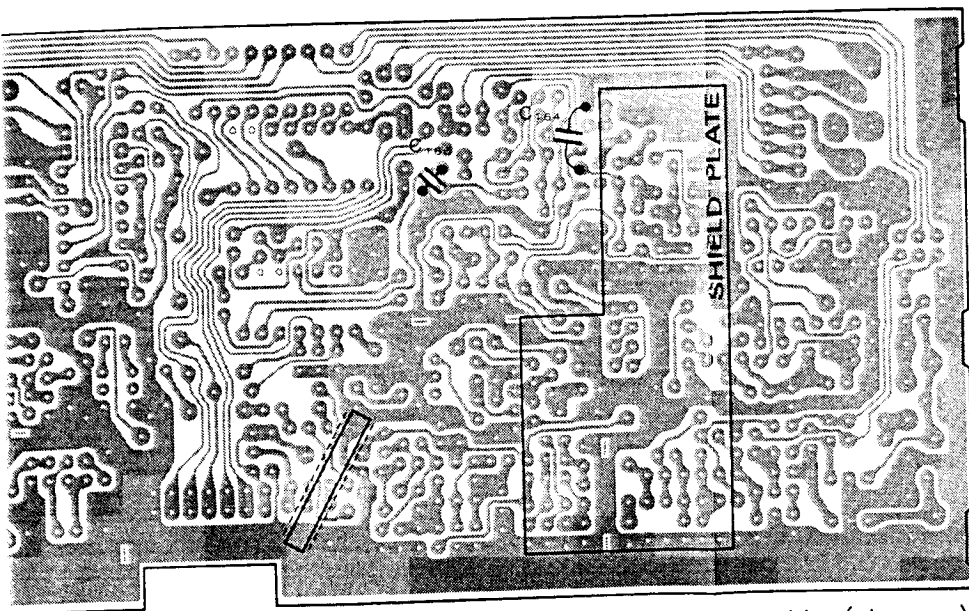

Solder side (obverse)

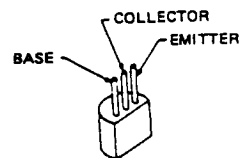

2SC458C (Q2004~2008,
2010,2011,
2015,2025)

2SC535B (Q2003,2016,
2022,2028-
2032)

2SC732TMBL (Q2020,2027)
2SC2053 (Q2034)

LOCAL UNIT IC VOLTAGE CHART

(DC VOLT)

	7	8	9	10	11	12	13	14	15	16	17	18	REMARKS
5													14MHz
0	0	0	0	0	0	4.8	0	0	5.0	5.0			14MHz, MODE USB
8	0	0	8.8	0	0	0	7.6	0	0	7.6	-0.4	0	14MHz, MODE USB
8	3.8	7.8											14MHz, MODE USB
8	3.8	7.7											14MHz, MODE USB
0	4.9	2.5											14MHz, MODE USB
0	0	0	2.5	0	2.5	2.5	2.3	4.9					14MHz, MODE USB
2	0.5	0	—	—	2.4	5.0	4.2	0					14MHz, MODE USB
6	2.6												14MHz, MODE USB
9	0.5	0	—	—	0.5	4.8	2.0	0					14MHz, MODE USB

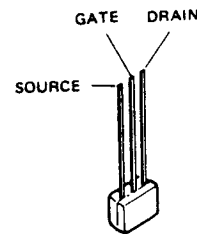

2SK184Y (Q2019,2026)

2S1

LOCAL UNIT VOLTAGE CHART (DC VOLT)

	E (S)	C (D)	B (G)	REMARKS
Q2003	3.1	8.1	3.9	
Q2004	3.5	8.1	4.2	
Q2005	1.4	8.1	2.2	
Q2006	0/0	0.7/0	0/0.7	RX/TX, MODE CW
Q2007	2.0	6.6	2.0	MODE USB
Q2008	1.7	8.0	2.4	MODE USB
Q2010	1.8	8.4	2.5	
Q2011	1.9	8.4	2.6	
Q2015	3.6	8.0	4.2	
Q2016	2.3	8.3	2.9	
Q2017	1.0	8.4	0	
Q2019	8.6	0.5	0.6	
Q2020	0	5.6	0.7	
Q2022	2.5	8.3	3.2	
Q2025	0/0	5.0/0	0/0.6	PLL LOCK/UNLOCK
Q2026	0.8	8.6	0.5	14MHz
Q2027	0.1	5.3	0.8	14MHz
Q2028	2.6	7.1	3.3	3.5MHz
Q2029	2.6	7.1	3.3	28MHz
Q2030	2.6	7.1	3.3	18MHz
Q2031	3.1	7.0	3.9	28MHz
Q2032	2.5	8.3	3.3	
Q2034	2.8	8.7	3.5	

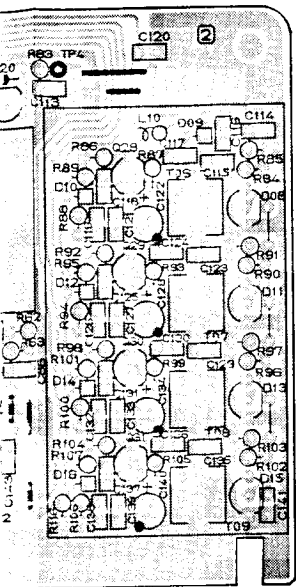

Component side (obverse)

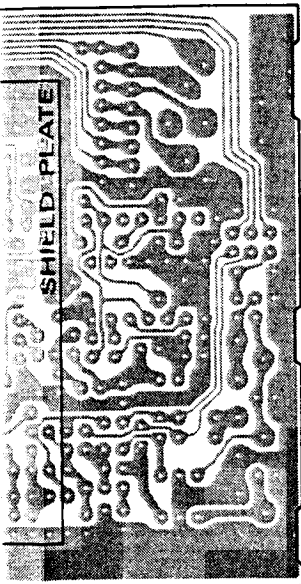

Solder side (obverse)

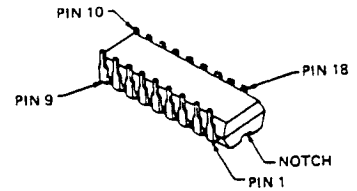

M54564P (Q2002)

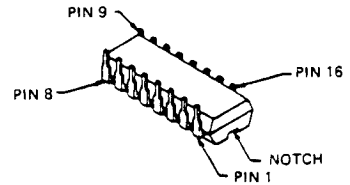

μPD4094BC (Q2001)

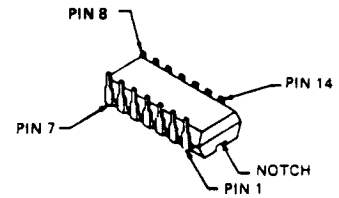

CX-7925B (Q2018,2024)

μPD4013BC (Q2014)

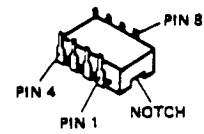

SN16913P (Q2009,2012)

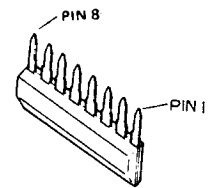

M54459L (Q2013)

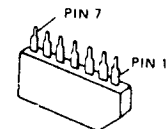

μPC1037H (Q2021)

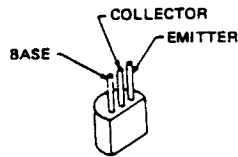

2SC458C (Q2004~2008,
2010,2011,
2015,2025)

2SC535B (Q2003,2016,
2022,2028-
2032)

2SC732TMBL (Q2020,2027)

2SC2053 (Q2034)

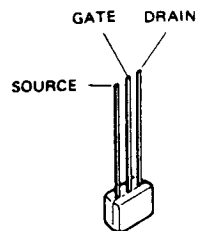

2SK184Y (Q2019,2026)

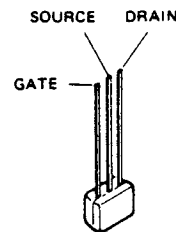

2SK192AGR (Q2017)

(DC VOLT)

16	17	18	REMARKS
5.0			14MHz
7.6	-0.4	0	14MHz, MODE USB
			14MHz, MODE USB
			14MHz, MODE USB
			14MHz, MODE USB
			14MHz, MODE USB
			14MHz, MODE USB
			14MHz, MODE USB
			14MHz, MODE USB
			14MHz, MODE USB

For Service Manuals Contact
MAURITRON TECHNICAL SERVICES
 8 Cherry Tree Rd, Chinnor
 Oxon OX9 4QY
 Tel:- 01844-351694 Fax:- 01844-352554
 Email:- enquiries@mauritron.co.uk

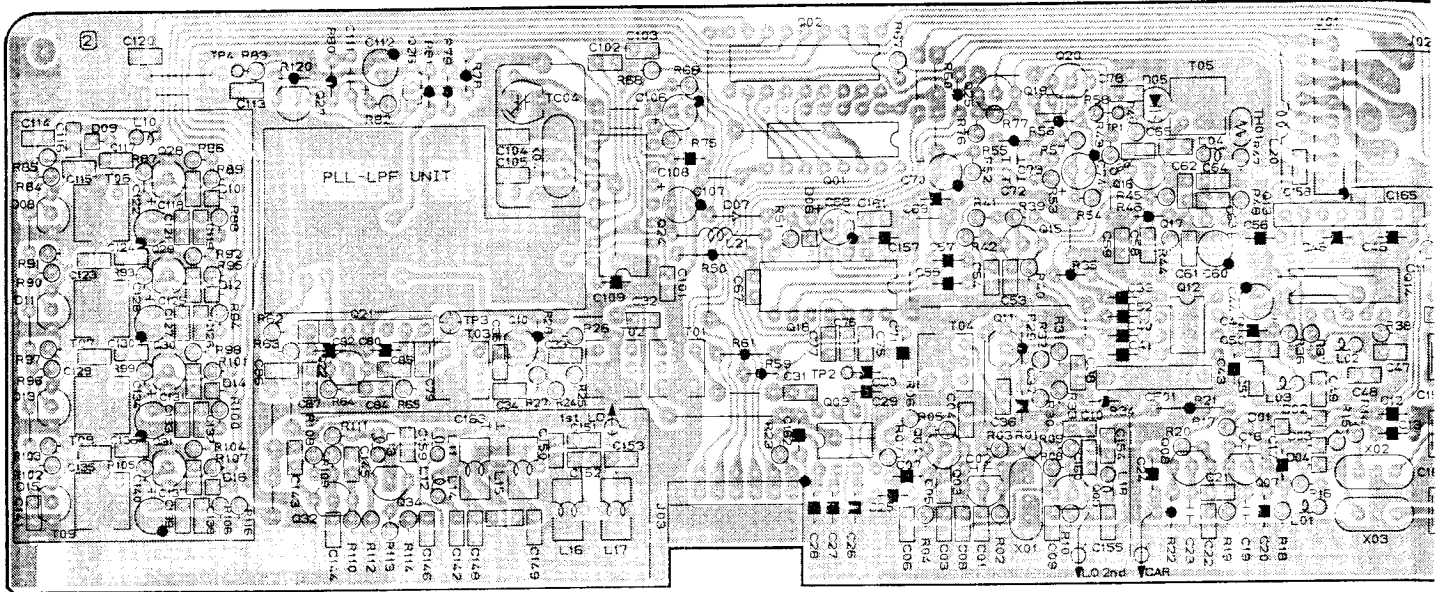

Component side (reverse)

PLL-LPF UNIT PARTS LAYOUT

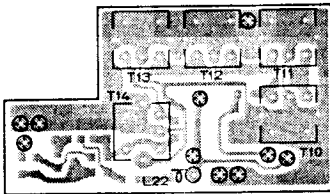

Component side (obverse)

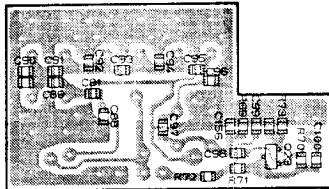

Solder side (obverse)

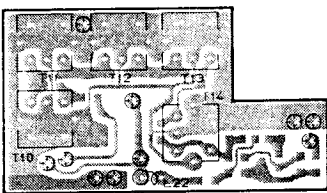

Component side (reverse)

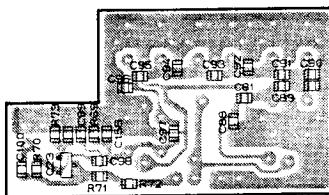

Solder side (reverse)

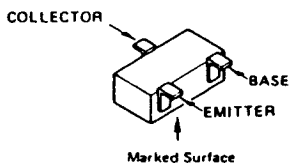

2SC2620QB (Q7023)

For Service Manuals Contact
MAURITRON TECHNICAL SERVICES
 8 Cherry Tree Rd, Chinnor
 Oxon OX9 4QY
 Tel: 01844-351694 Fax: 01844-352554
 Email: enquiries@mauritron.co.uk

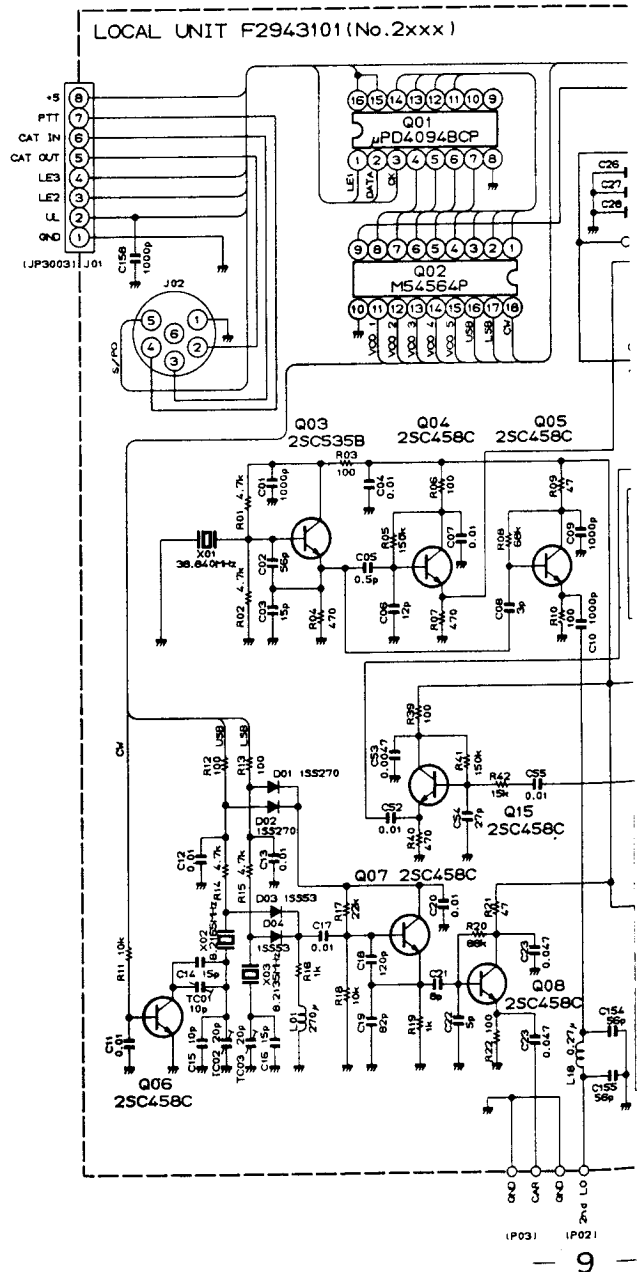

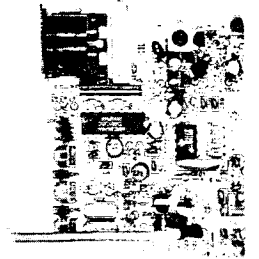
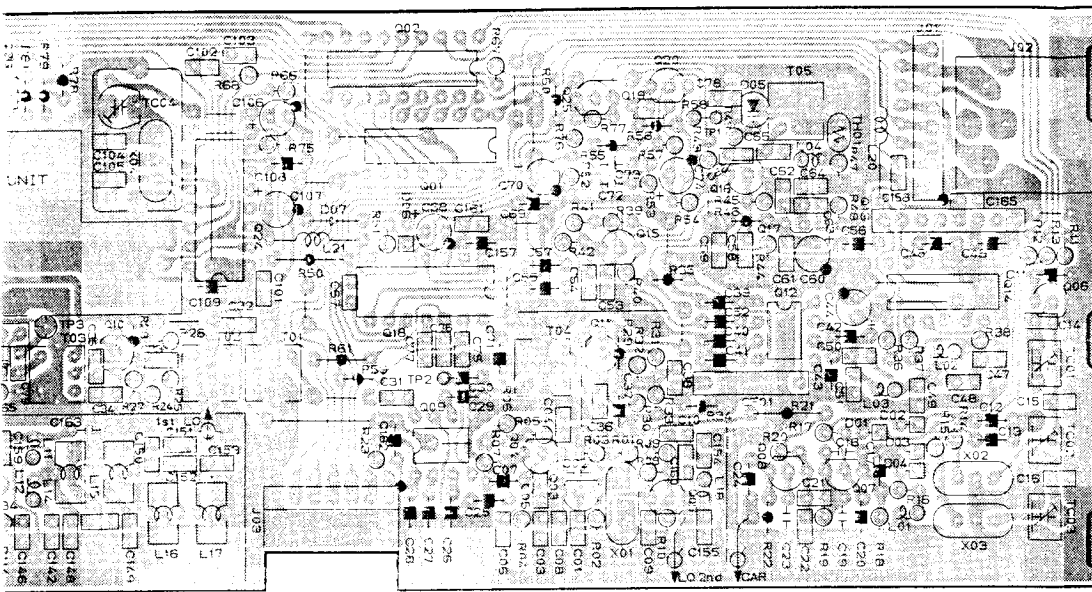

PARTS LAYOUT

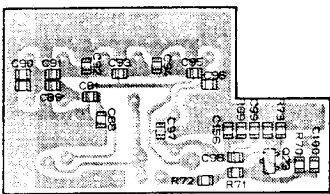

Solder side (obverse)

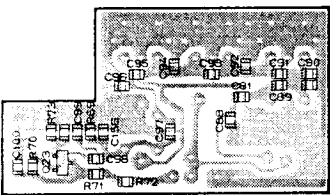

Solder side (reverse)

LOCAL UNIT F2943101 (No.2xxx)

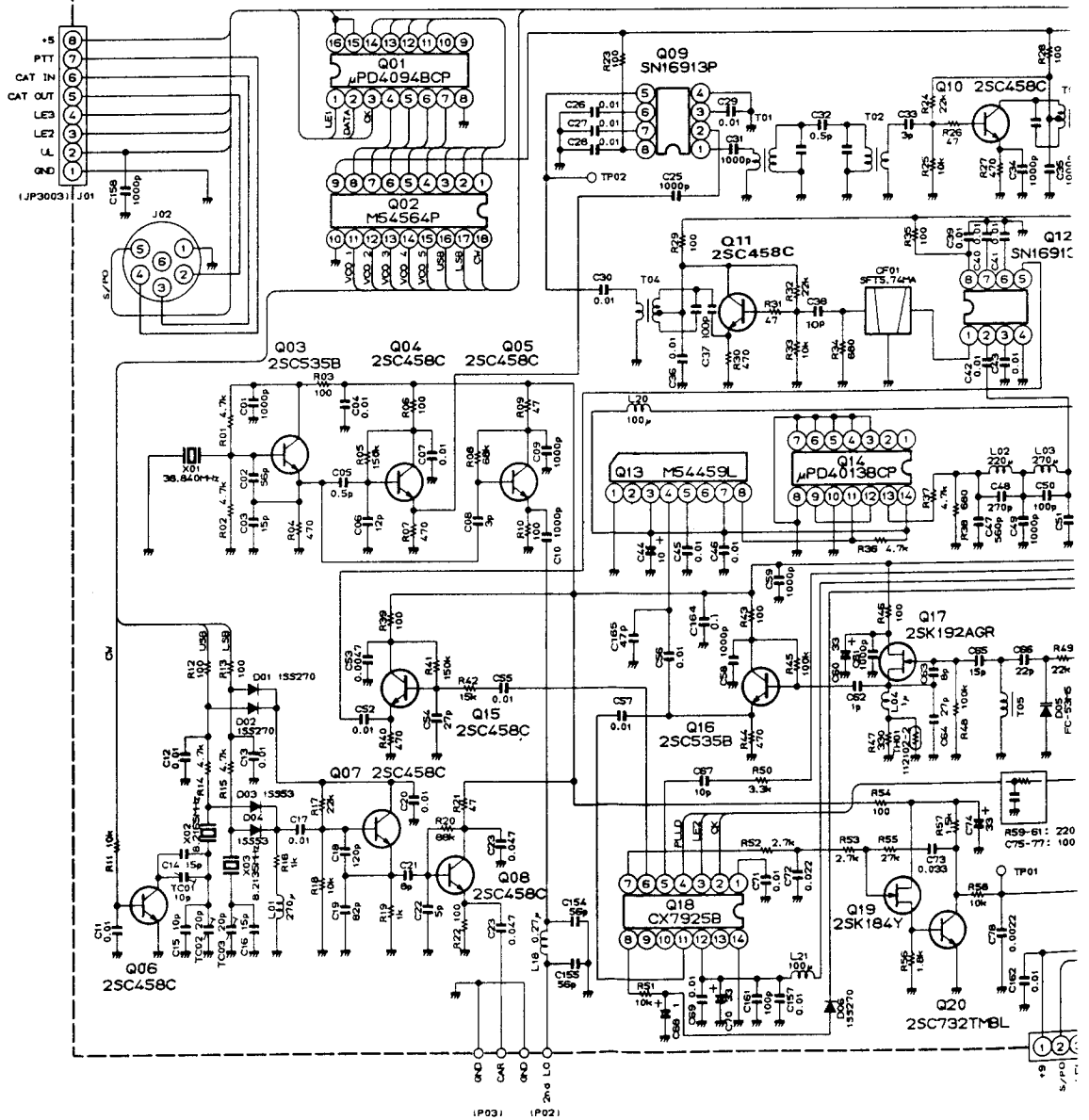

32620QB (Q7023)

LOCAL UNIT

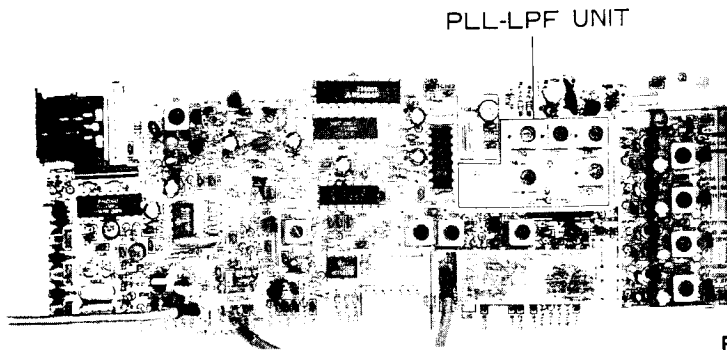
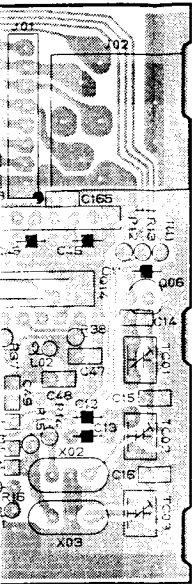

PLL-LPF UNIT

For Service Manuals Contact
MAURITRON TECHNICAL SERVICES
 8 Cherry Tree Rd, Chinnor
 Oxon OX9 4QY
 Tel: 01844-351694 Fax: 01844-352554
 Email: enquiries@mauritron.co.uk

CIRCUIT DIAGRAM

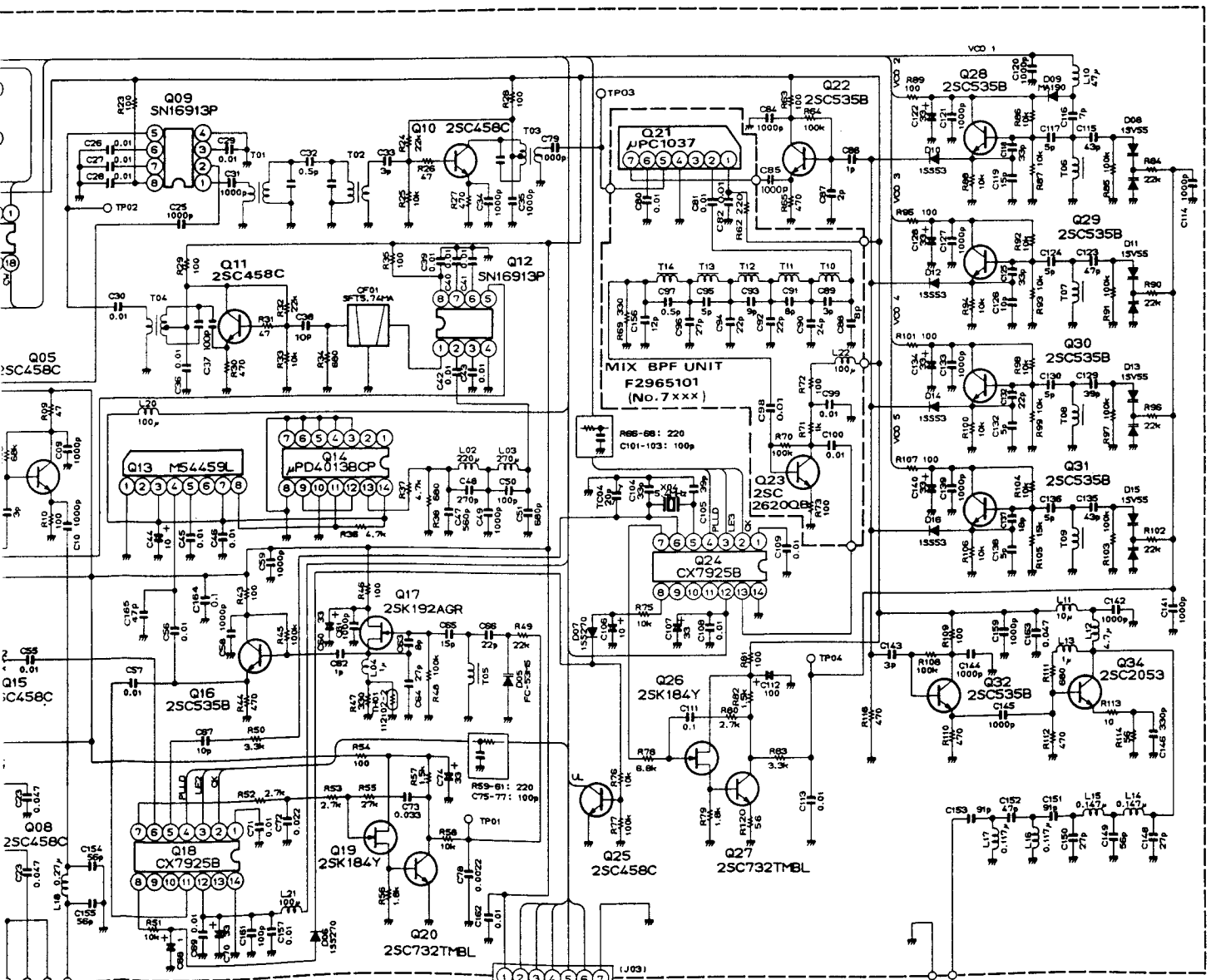

RESISTOR VALUES ARE IN Ω , $k\Omega$, $M\Omega$;
 CAPACITOR VALUES ARE IN pF , $50\mu F$;
 INDUCTOR VALUES ARE IN mH ;
 ELECTROLYTIC CAPACITOR VALUES ARE IN μF , $10\mu F$.
 UNLESS OTHERWISE NOTED.

PARTS LAYOUT

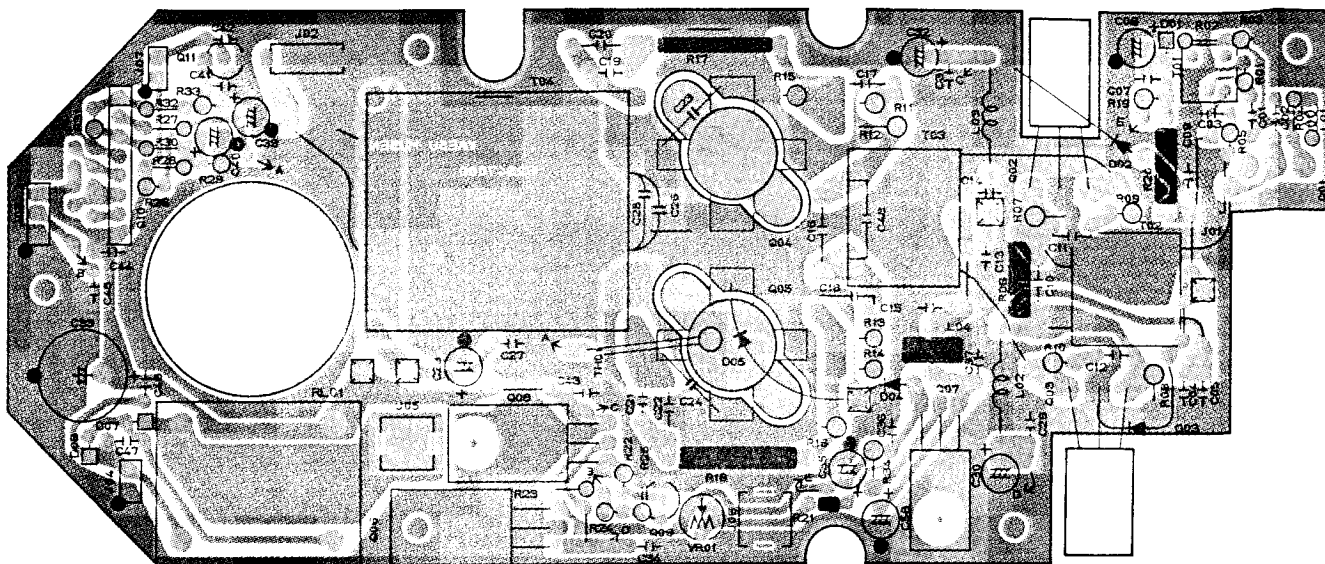

Component side (obverse)

For Service Manuals Contact
MAURITRON TECHNICAL SERVICES
 8 Cherry Tree Rd, Chinnor
 Oxon OX9 4QY
 Tel: 01844-351694 Fax: 01844-352554
 Email: enquiries@mauritron.co.uk

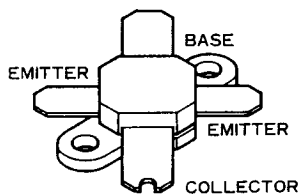

2SC3240 (Q5004,5005)

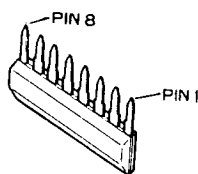

M5218L (Q5010)

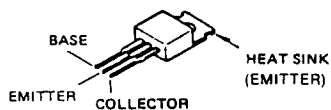

2SB824R (Q5008)
 2SC2166 (Q5001)

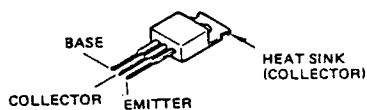

2SC3133 (Q5002,5003)

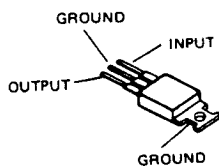

μPC7808H (Q5006)

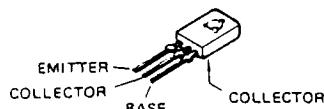

2SD882Q (Q5007)

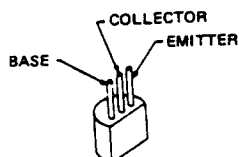

2SC458D (Q5009)
 2SC2001 (Q5011)

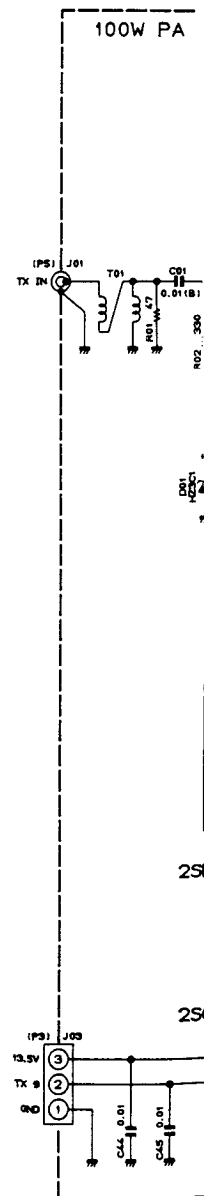

CIRCU

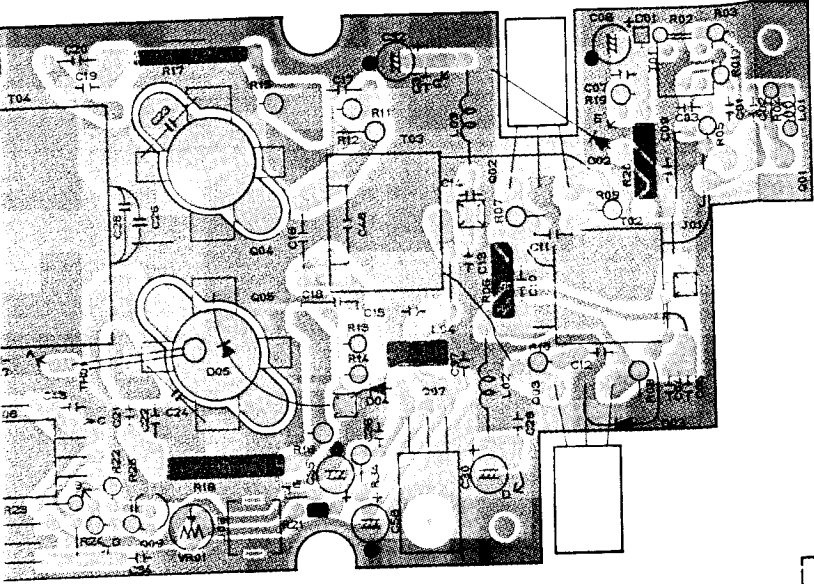

PA UNIT VOLTAGE CHART (DC VOLT)

	E	C	B	REMARKS
Q5001	0/0.4	0/13.4	0/1.2	RX/TX
Q5002	0/0	13.5/13.5	0/0.7	RX/TX
Q5003	0/0	13.5/13.5	0/0.7	RX/TX
Q5004	0/0	13.5/13.5	0/0.6	RX/TX
Q5005	0/0	13.5/13.5	0/0.6	RX/TX
Q5007	0.4/1.4	0/7.6	0/0.7	RX/TX
Q5008	13.5/13.5	0.5/13.4	13.5/12.7	RX/TX
Q5009	0/0	13.5/0.1	0/0.7	RX/TX
Q5010	0	13.5	0.2	

PA UNIT IC VOLTAGE CHART

	1 (IN)	2 (GND)	3 (OUT)	4	5	6	7
Q5006	0.4/13.4	0/0	0/8.0				
Q5010	1.4/1.3	4.9-7.0/10-10	2.8/3.1	0/0	-	-	-

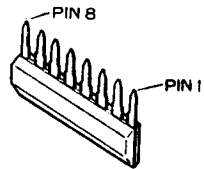

M5218L (Q5010)

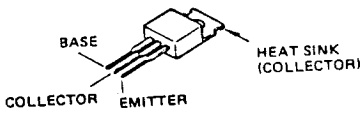

2SC3133 (Q5002, 5003)

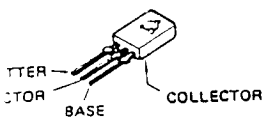

2SD882Q (Q5007)

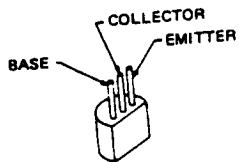

2SC458D (Q5009)

2SC2001 (Q5011)

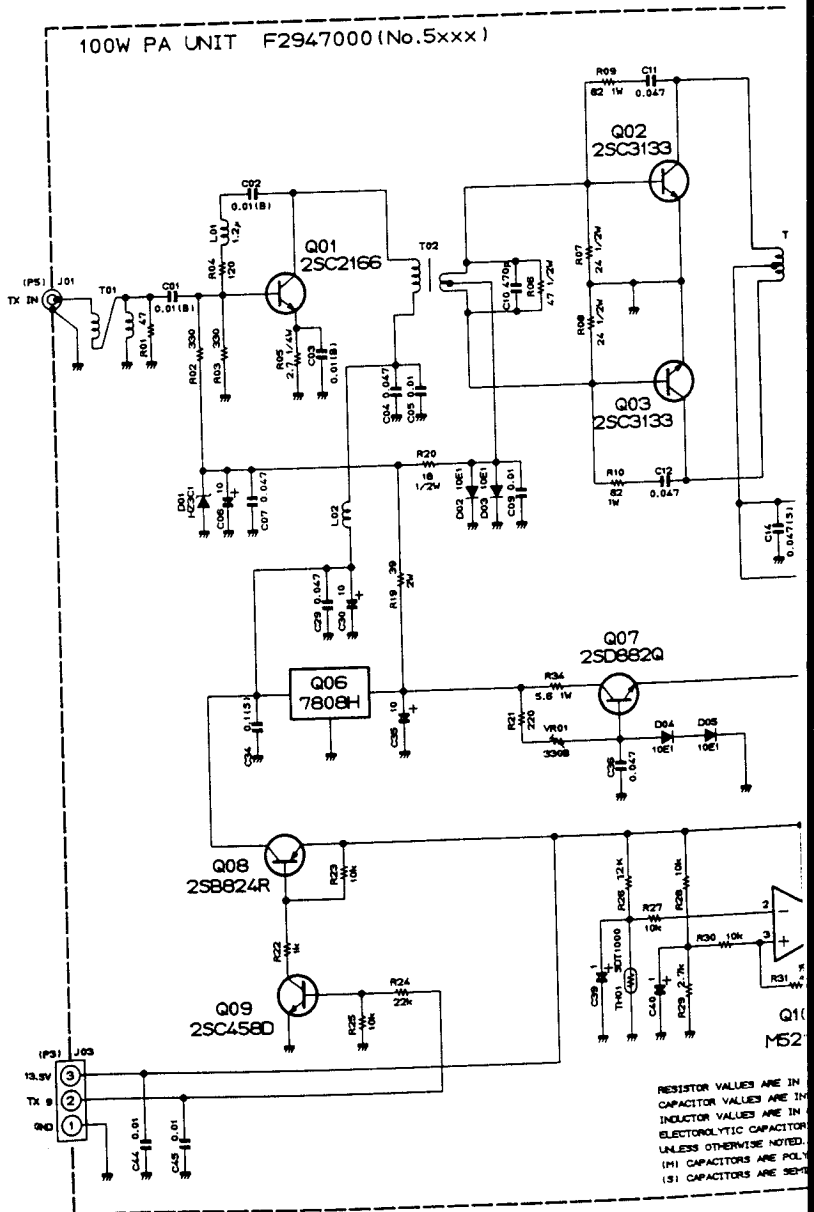

CIRCUIT DIAGRAM

PA UNIT VOLTAGE CHART (DC VOLT)

	E	C	B	REMARKS
Q5001	0/0.4	0/13.4	0/1.2	RX/TX
Q5002	0/0	13.5/13.5	0/0.7	RX/TX
Q5003	0/0	13.5/13.5	0/0.7	RX/TX
Q5004	0/0	13.5/13.5	0/0.6	RX/TX
Q5005	0/0	13.5/13.5	0/0.6	RX/TX
Q5007	0.4/1.4	0/7.6	0/0.7	RX/TX
Q5008	13.5/13.5	0.5/13.4	13.5/12.7	RX/TX
Q5009	0/0	13.5/0.1	0/0.7	RX/TX
Q5010	0	13.5	0.2	

For Service Manuals Contact
MAURITRON TECHNICAL SERVICES
 8 Cherry Tree Rd, Chinnor
 Oxon OX9 4QY
 Tel:- 01844-351694 Fax:- 01844-352554
 Email:- enquiries@maurtron.co.uk

PA UNIT IC VOLTAGE CHART (DC VOLT)

	1 (IN)	2 (GND)	3 (OUT)	4	5	6	7	8	REMARKS
Q5006	0.4/13.4	0/0	0/8.0						RX/TX
Q5010	1.4/1.3	4.0-7.0/1.0-3.0	2.8/3.1	0/0	--	--	--	13.5/13.5	FAN OFF/ON

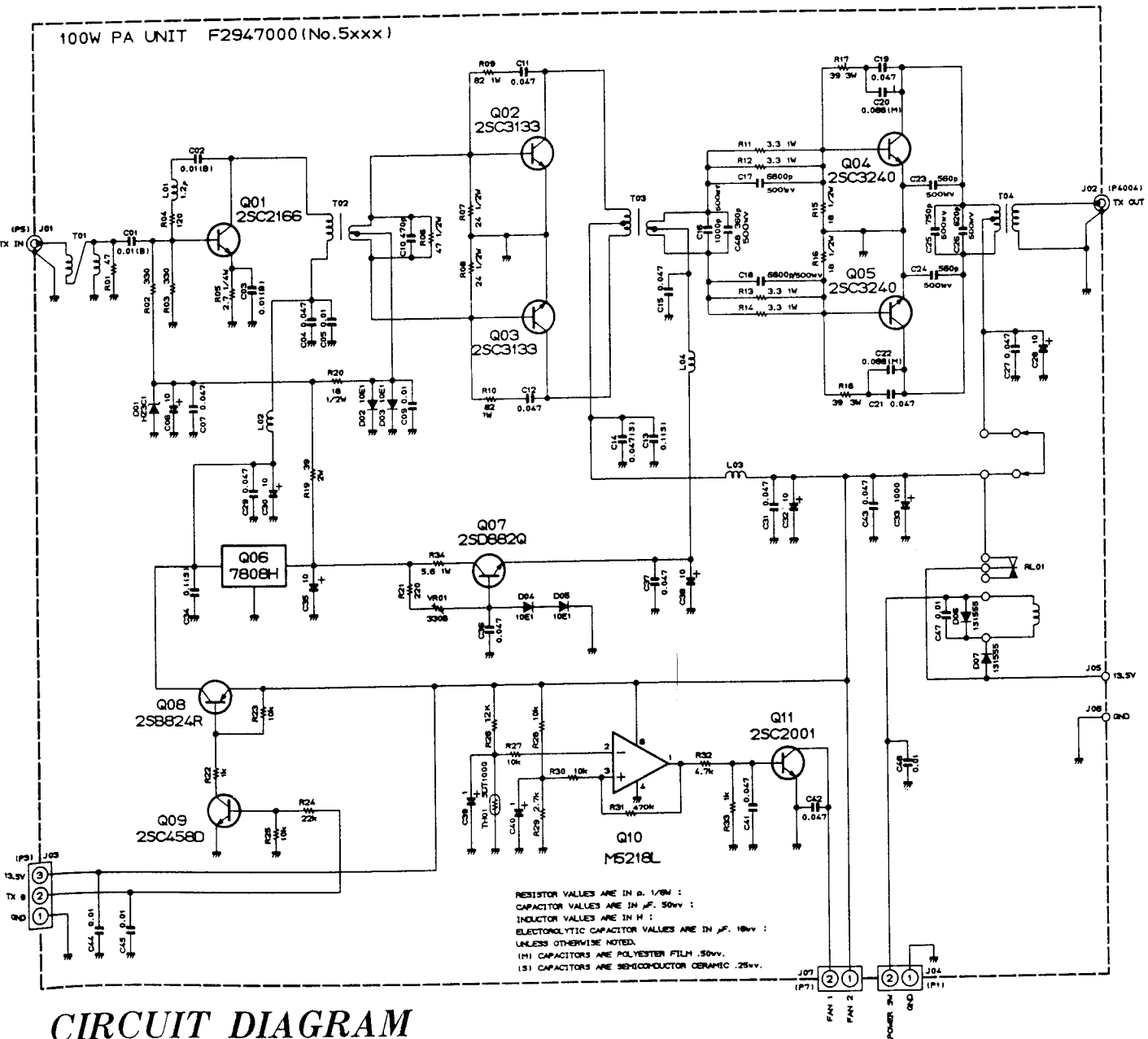

PARTS LAYOUT

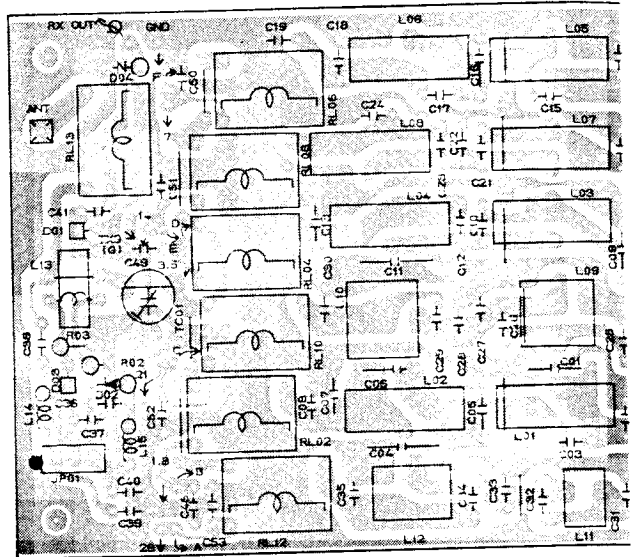

Component

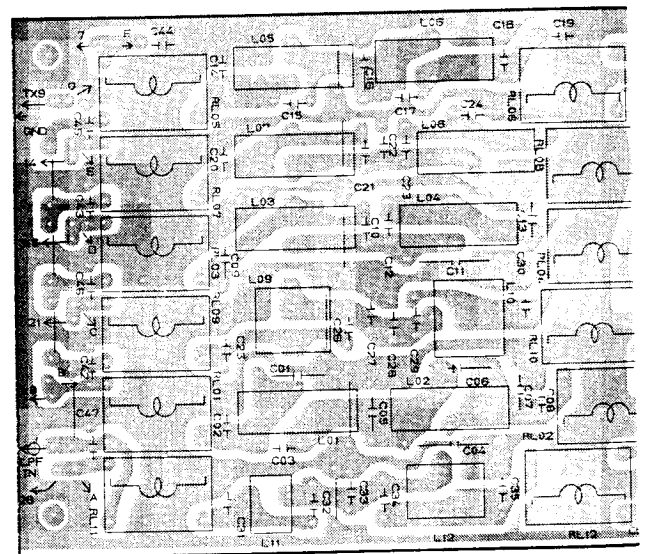

Component

For Service Manuals Contact
MAURITRON TECHNICAL SERVICES
 8 Cherry Tree Rd, Chinnor
 Oxon OX9 4QY
 Tel:- 01844-351694 Fax:- 01844-352554
 Email:- enquiries@mauritron.co.uk

PARTS LAYOUT

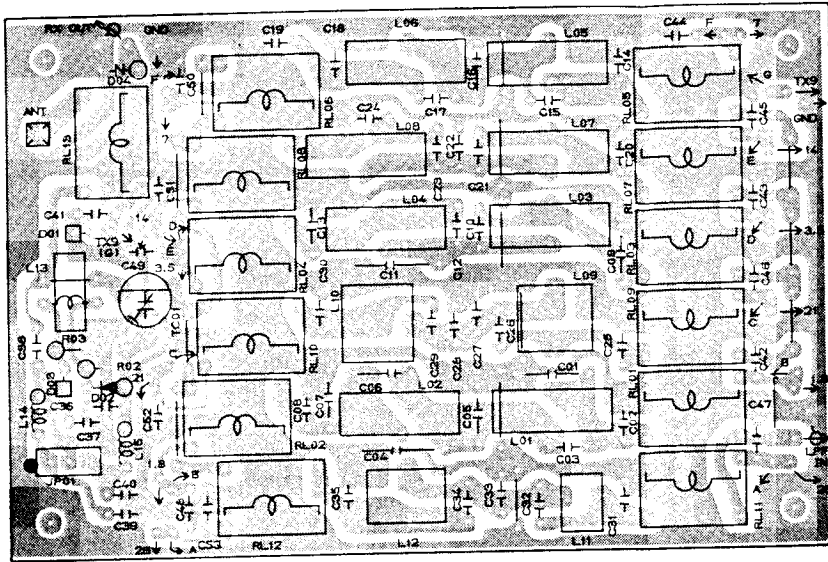

Component side (obverse)

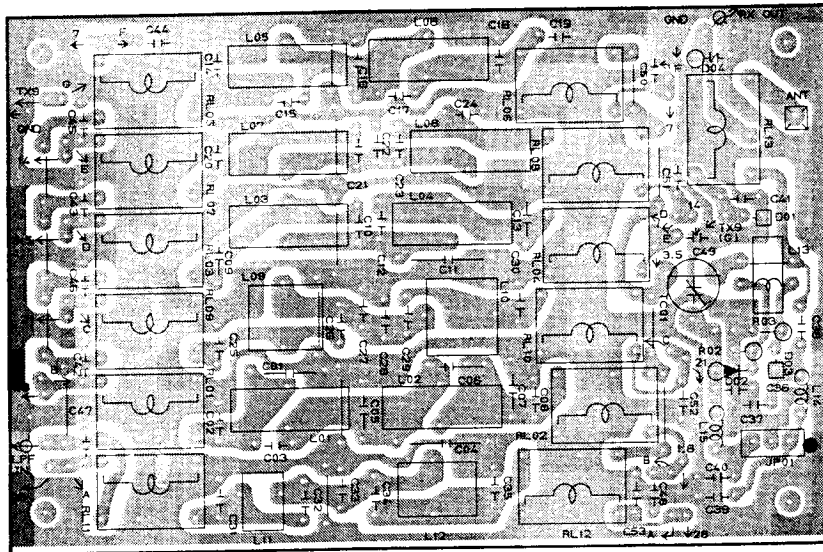

Component side (reverse)

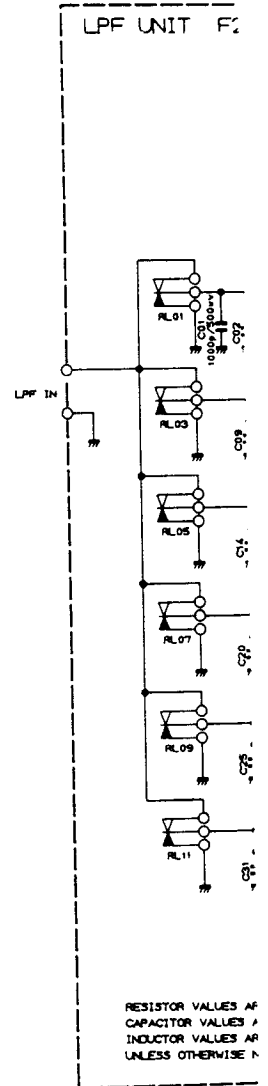

CIRCUIT

LPF UNIT

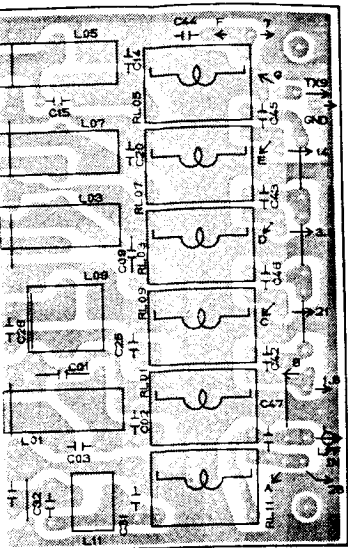

component side (obverse)

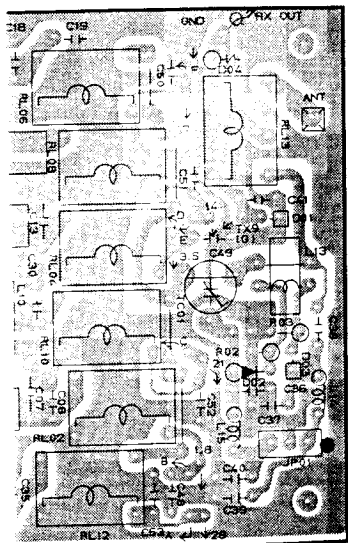

component side (reverse)

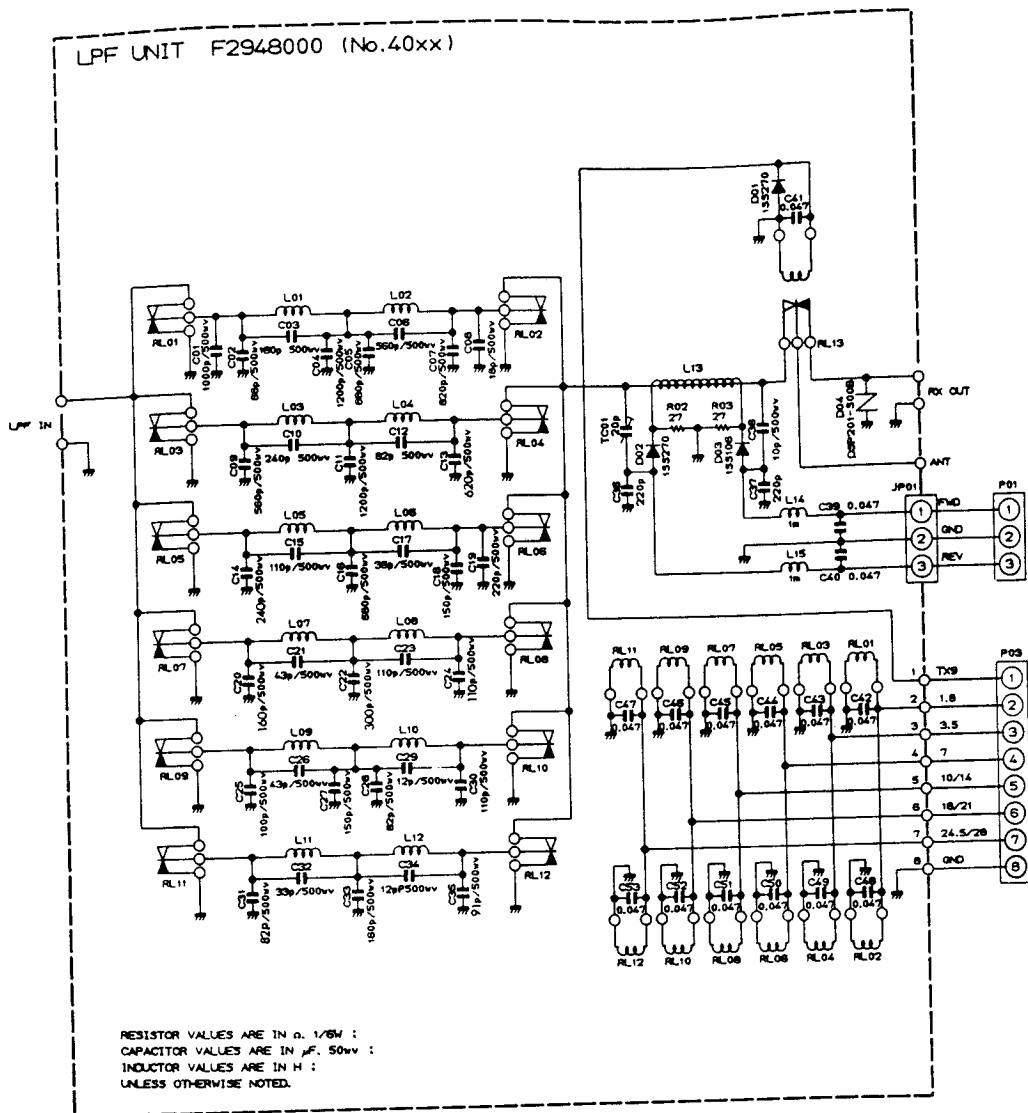

CIRCUIT DIAGRAM

For Service Manuals Contact
 MAURITRON TECHNICAL SERVICES
 8 Cherry Tree Rd, Chinnor
 Oxon OX9 4QY
 Tel: 01844-351694 Fax: 01844-352554
 Email: enquiries@mauritron.co.uk

DISPLAY UNIT

PARTS LAYOUT

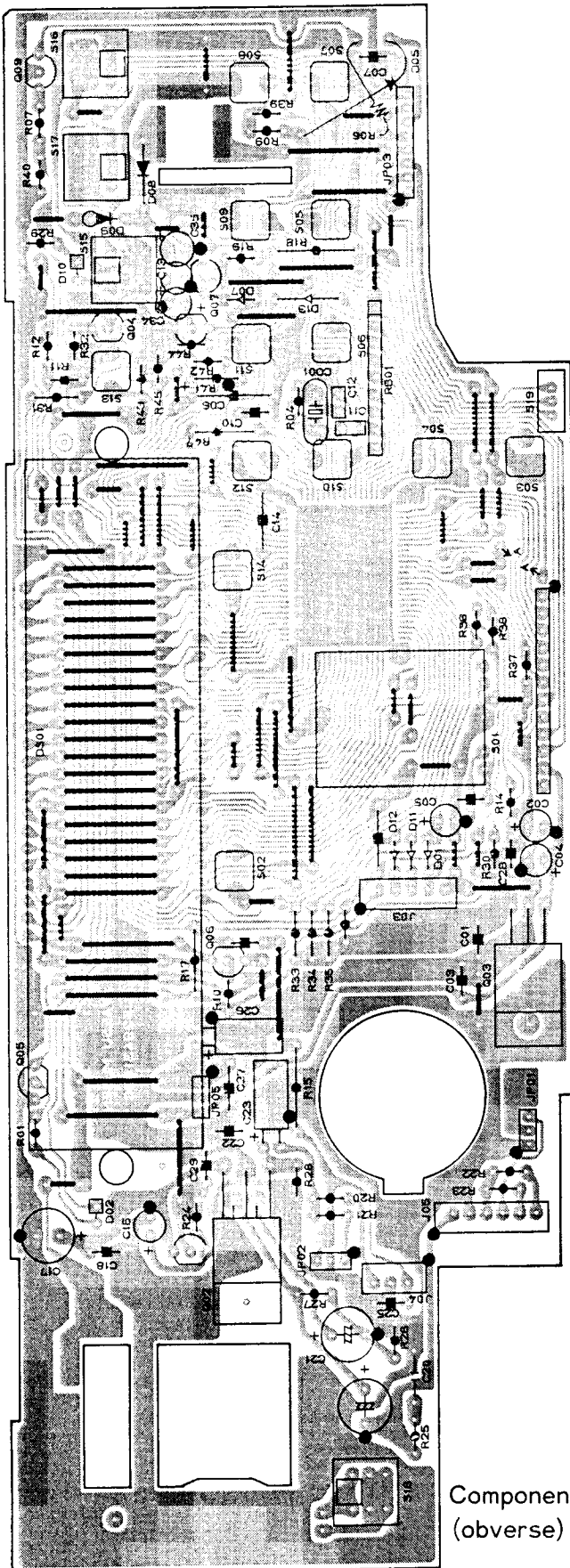

Component side
(obverse)

For Service Manuals Contact
MAURITRON TECHNICAL SERVICES
8 Cherry Tree Rd, Chinnor
Oxon OX9 4QY
Tel: 01844-351694 Fax: 01844-352554
Email: enquiries@mauritron.co.uk

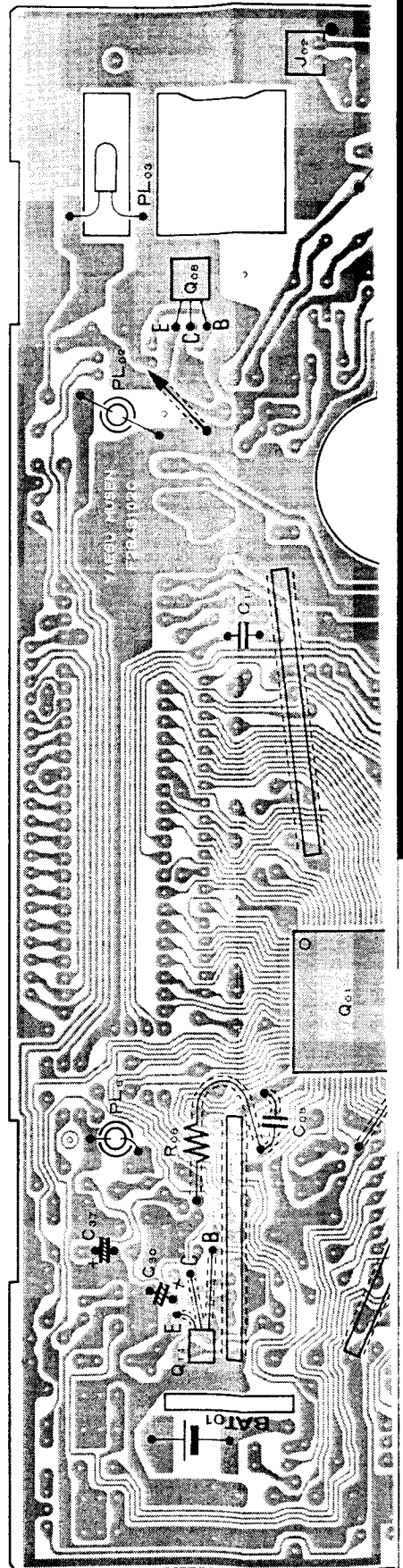

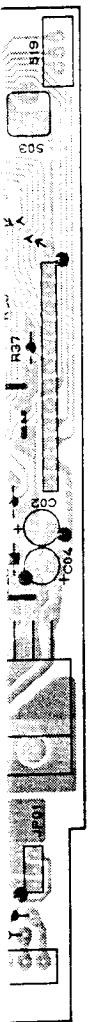

Component side
(reverse)

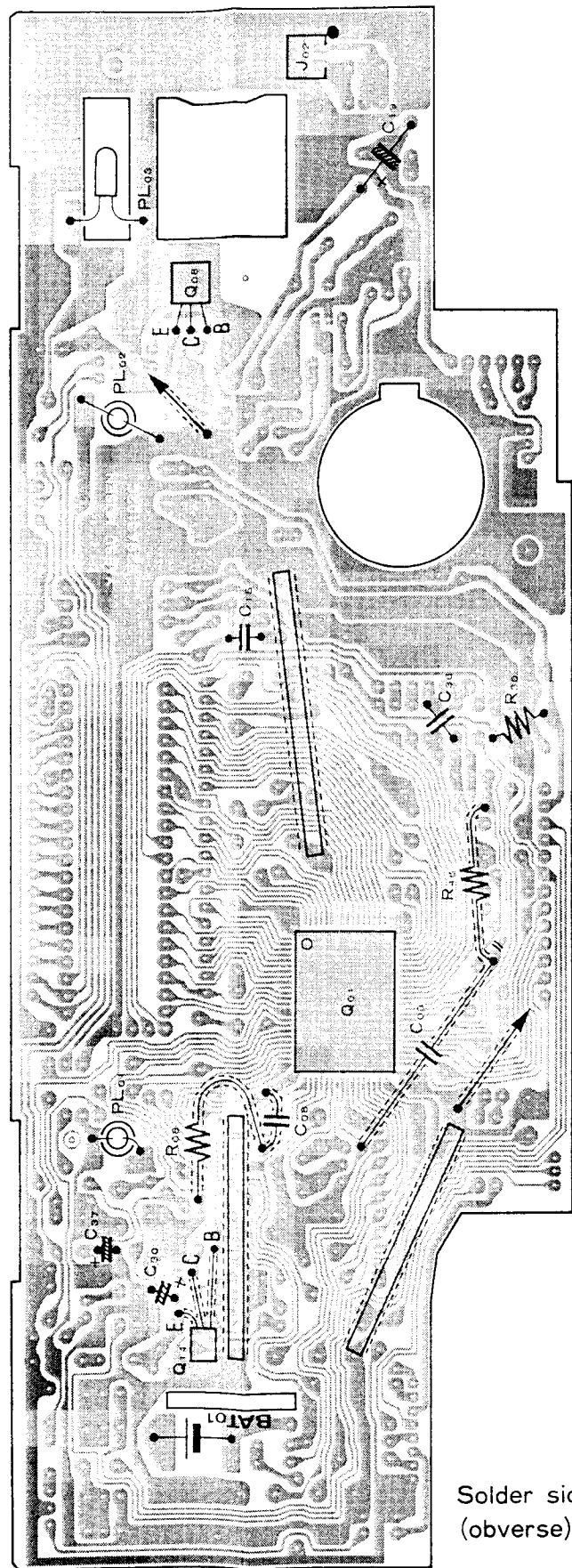

Solder side
(obverse)

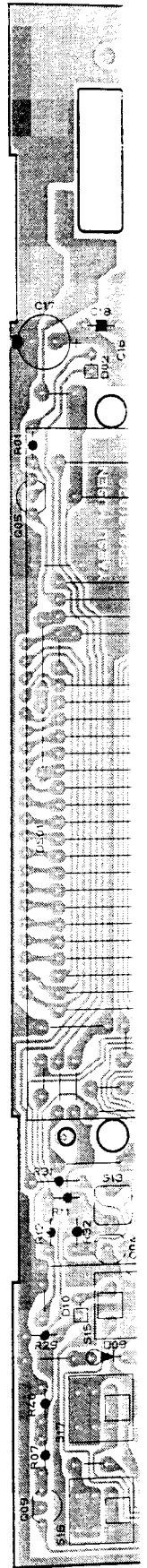

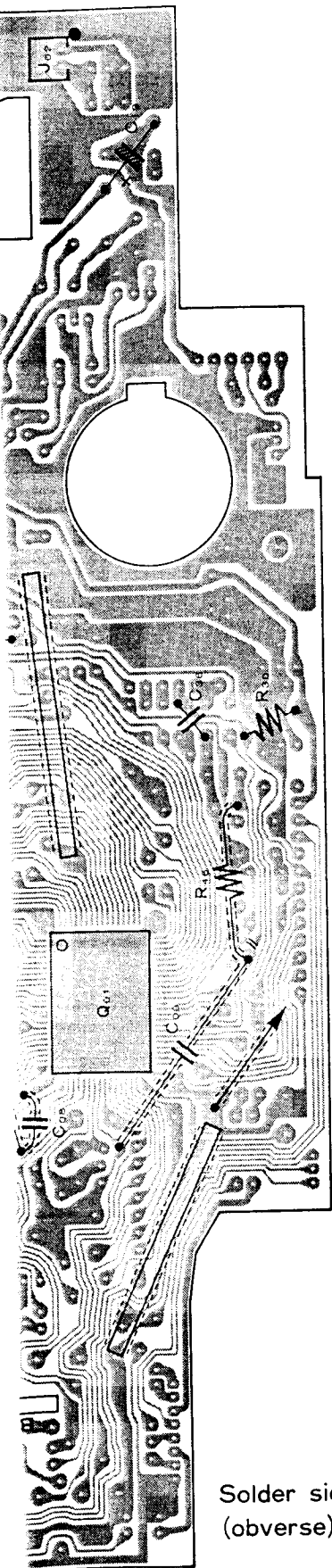

Solder side
(obverse)

For Service Manuals Contact
MAURITRON TECHNICAL SERVICES
 8 Cherry Tree Rd, Chinnor
 Oxon OX9 4QY
 Tel: 01844-351694 Fax: 01844-352554
 Email: enquiries@mauritron.co.uk

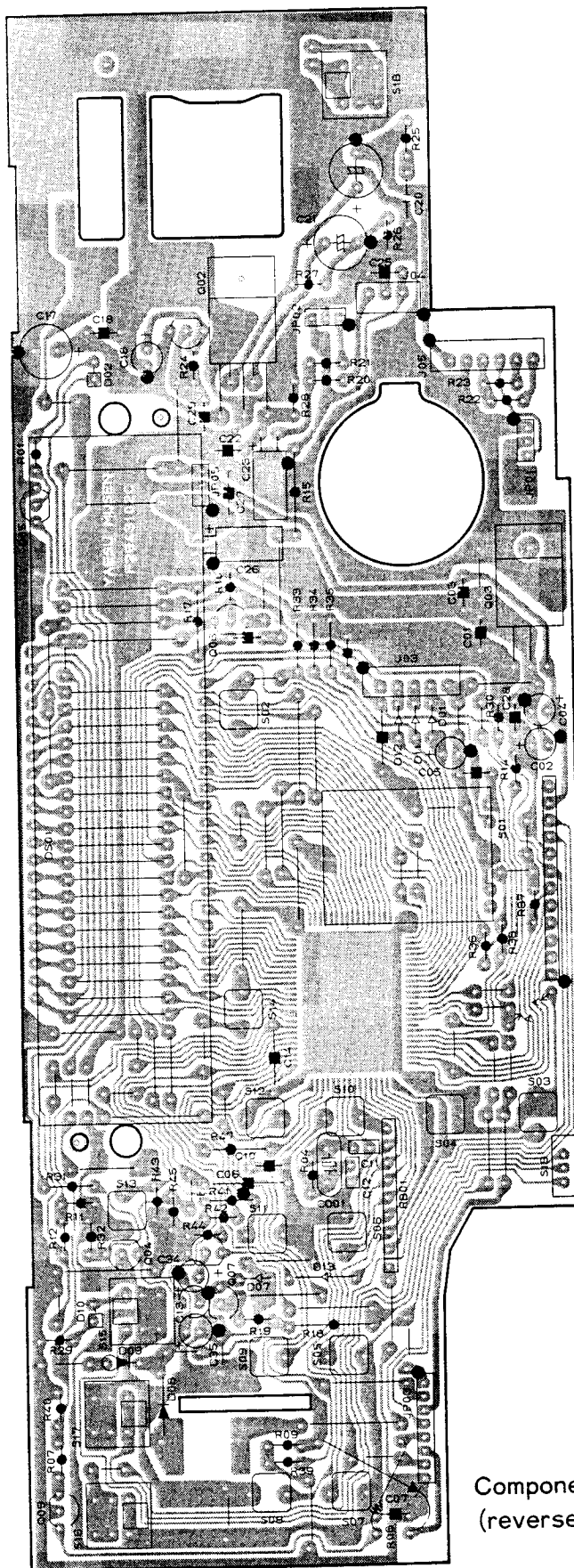

Component side
(reverse)

CIRCUIT DIAGRAM

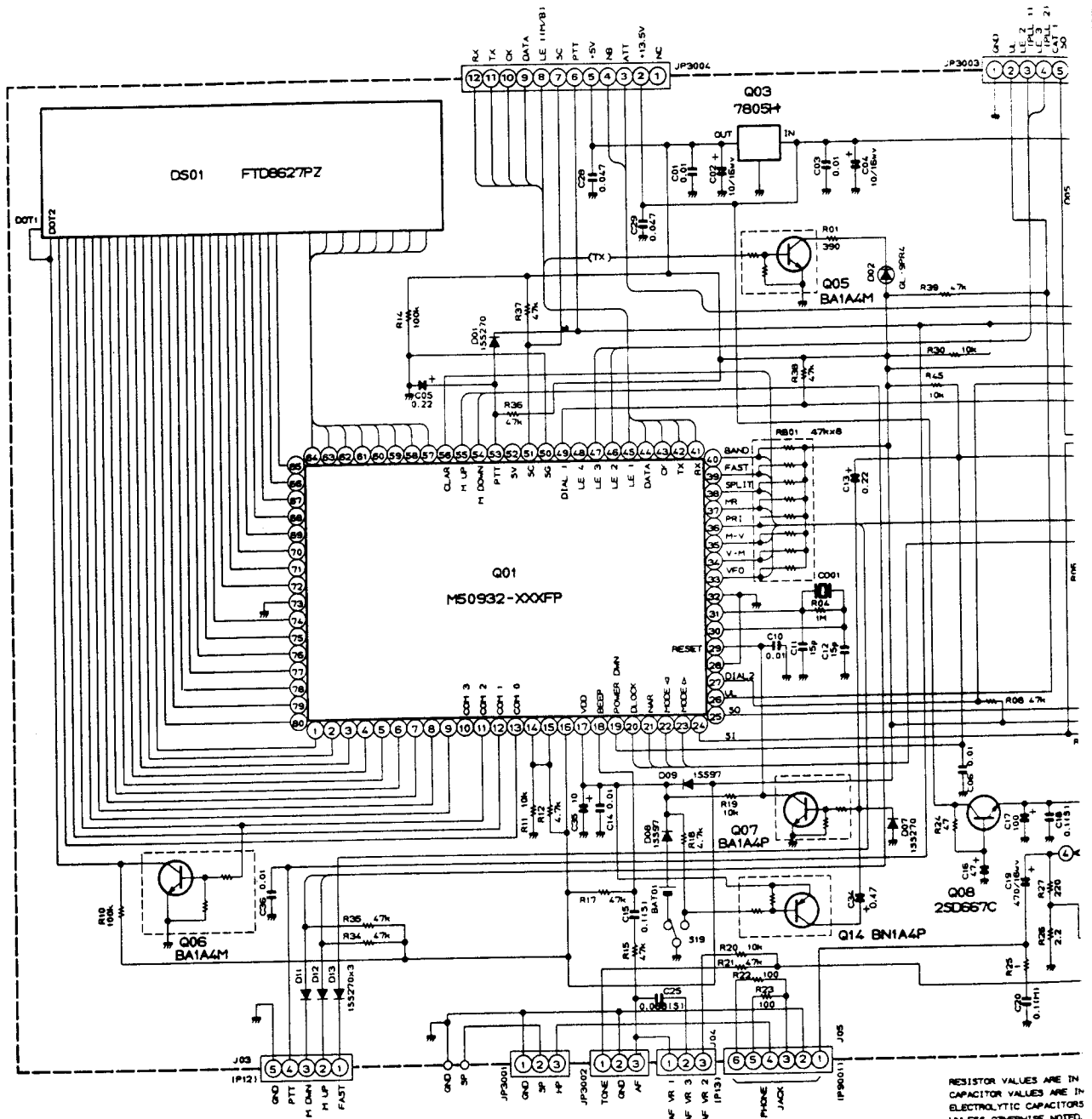

RESISTOR VALUES ARE IN CAPACITOR VALUES ARE IN UNLESS OTHERWISE NOTED. POLYESTER CAPACITORS ARE POLYESTER CAPACITORS ARE CERAMIC CAPACITORS ARE TANTALUM

For Service Manuals Contact
MAURITRON TECHNICAL SERVICES
 8 Cherry Tree Rd, Chinnor
 Oxon OX9 4QY
 Tel: 01844-351694 Fax: 01844-352554
 Email: enquiries@mauritron.co.uk

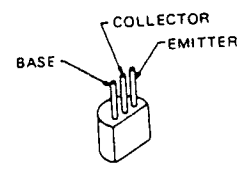

2SC458 (Q3009)
 2SD667C (Q3008)

COLLECT
 BASE —

BA1A4P
 BA1A4P
 BN1A4P

CIRCUIT DIAGRAM

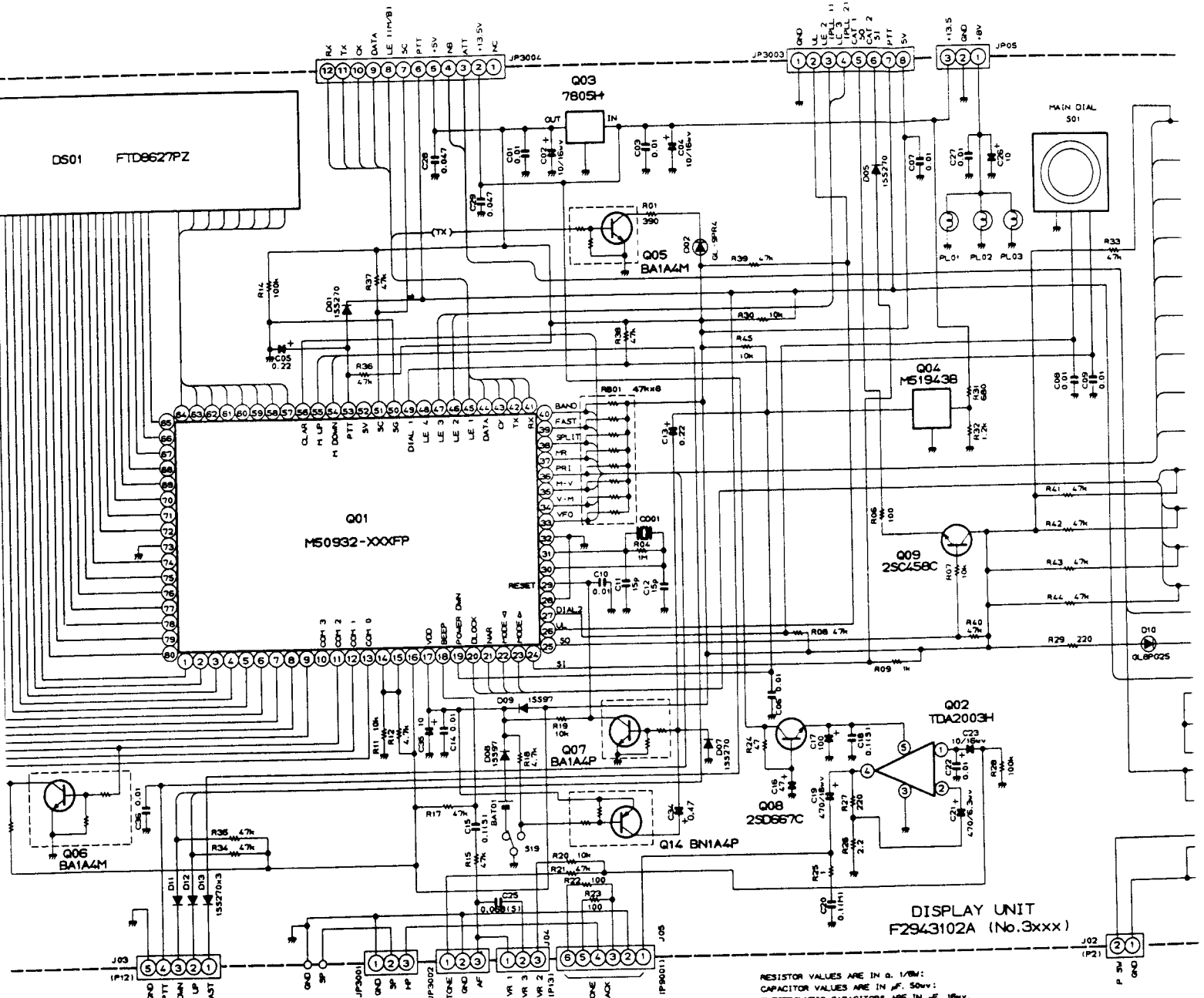

RESISTOR VALUES ARE IN Ω , 1/10W;
 CAPACITOR VALUES ARE IN μ F, 50V;
 ELECTROLYTIC CAPACITORS ARE IN μ F, 16V,
 UNLESS OTHERWISE NOTED.
 (M)CAPACITORS ARE POLYESTER FILM, 50V;
 (S)CAPACITORS ARE SEMICONDUCTOR CERAMIC, 25V;
 (T)CAPACITORS ARE TANTALUM, 25V.

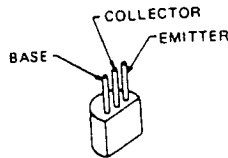

2SC458 (Q3009)
 2SD667C (Q3008)

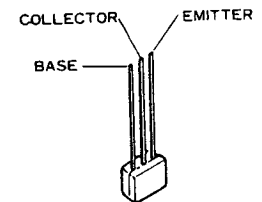

BA1A4M (Q3005,3006)
 BA1A4P (Q3007)
 BN1A4P (Q3014)



M51943E

DISPLAY UNIT VOLTAGE CHART (DC VOLT)

	E	C	B	REMARKS
Q3005	0/0	3.5/0	0/4.5	RX/TX
Q3006	2.7	0.8	0	
Q3007	0	4.6	0	
Q3008	12.7	13.4	13.4	
Q3009	4.2	5.0	4.6	
Q3014	4.6	0	4.0	

DISPLAY UNIT VOLTAGE CHART (DC VOLT)

	1 (IN)	2 (GND)	3 (OUT)	4	5	REMARKS
Q3002	0.7	0.1	0	4.8	12.7	
Q3003	13.5	0	5.0			
Q3004	8.3	0	5.0			

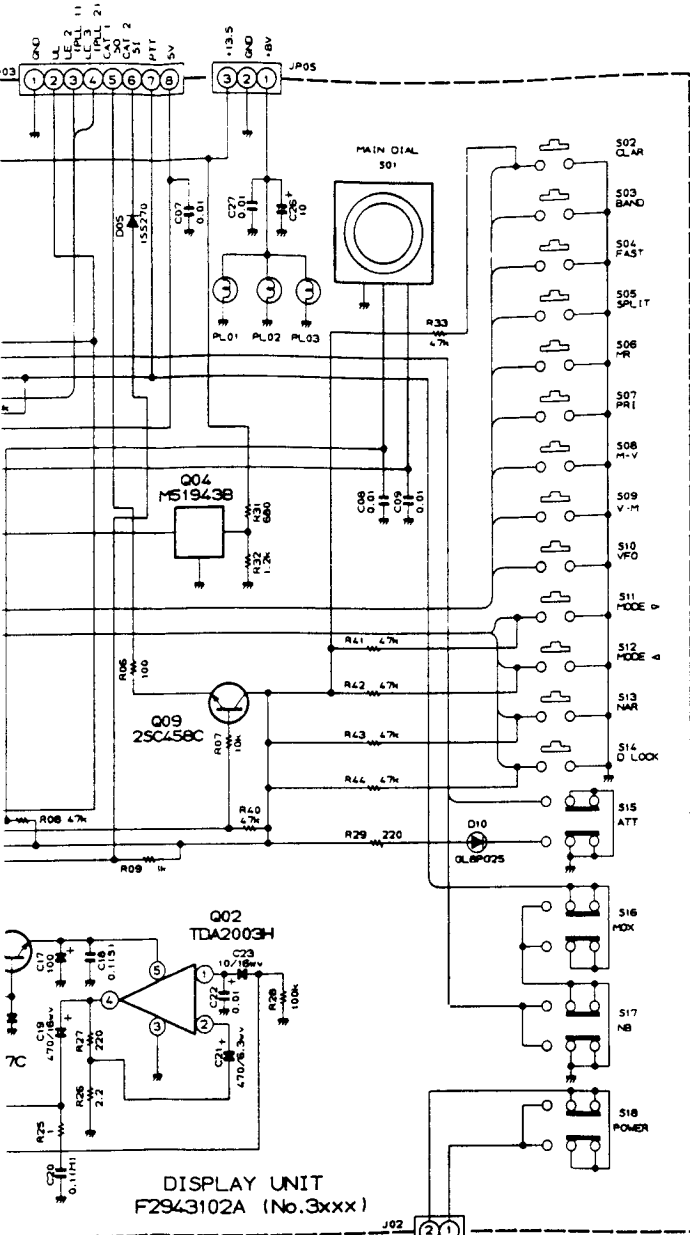

OR VALUES ARE IN Ω, 1/10W;
 TOR VALUES ARE IN μF, 50V;
 POLYLYTIC CAPACITORS ARE IN μF, 16V;
 ; OTHERWISE NOTED.
 *CAPACITORS ARE POLYESTER FILM, 50V;
 *CAPACITORS ARE SEMICONDUCTOR CERAMIC, 25V;
 *CAPACITORS ARE TANTALUM, 25V.

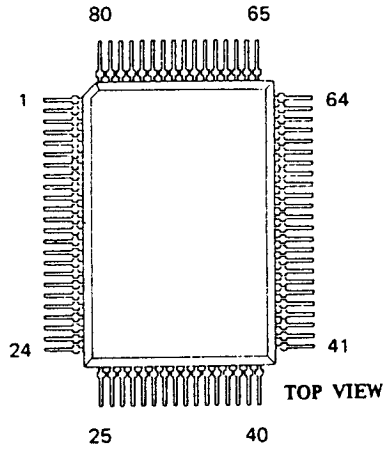

M50932-501FP (Q3001)

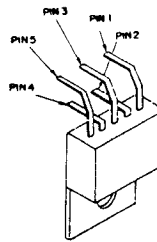

TDA2003H (Q3002)

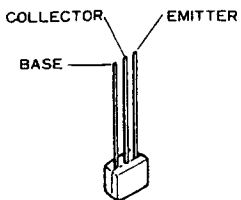

BA1A4M (Q3005, Q3006)

BA1A4P (Q3007)

BN1A4P (Q3014)

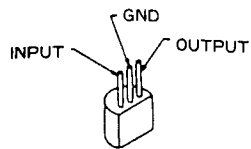

M51943BSL (Q3004)

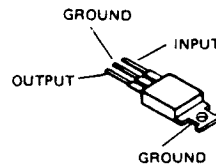

μPC7805H (Q3003)

For Service Manuals Contact
MAURITRON TECHNICAL SERVICES
 8 Cherry Tree Rd, Chinnor
 Oxon OX9 4QY
 Tel: 01844-351694 Fax: 01844-352554
 Email: enquiries@mauritron.co.uk

For Service Manuals Contact
MAURITRON TECHNICAL SERVICES
 8 Cherry Tree Rd, Chinnor
 Oxon OX9 4QY
 Tel:- 01844-351694 Fax:- 01844-352554
 Email:- enquiries@mauritron.co.uk

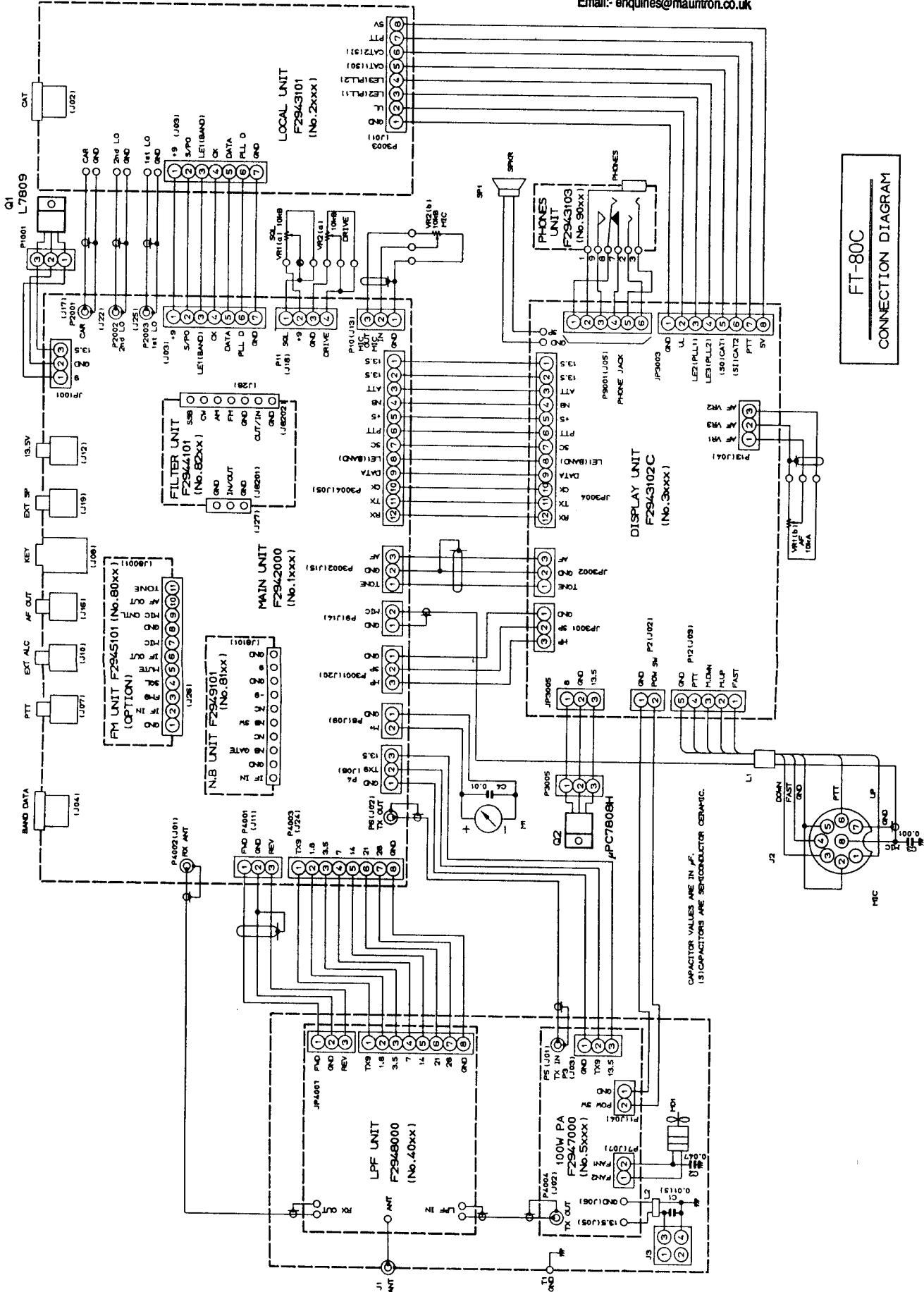

FT-80C
 CONNECTION DIAGRAM

TRANSMIT

For Service Manuals Contact
MAURITRON TECHNICAL SERVICES
 8 Cherry Tree Rd, Chinnor
 Oxon OX9 4QY
 Tel: 01844-351694 Fax: 01844-352564
 Email: enquiries@mauritron.co.uk

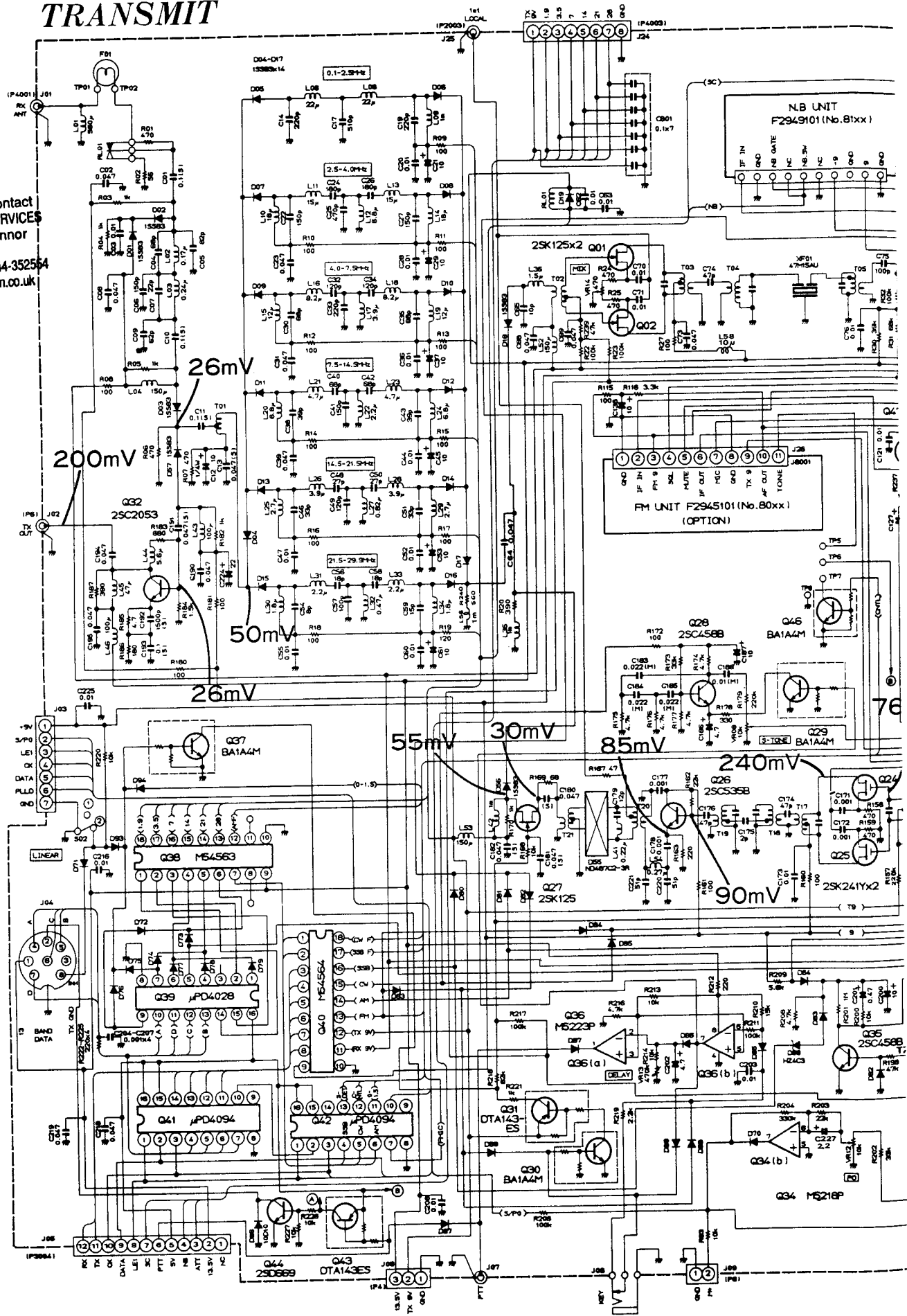

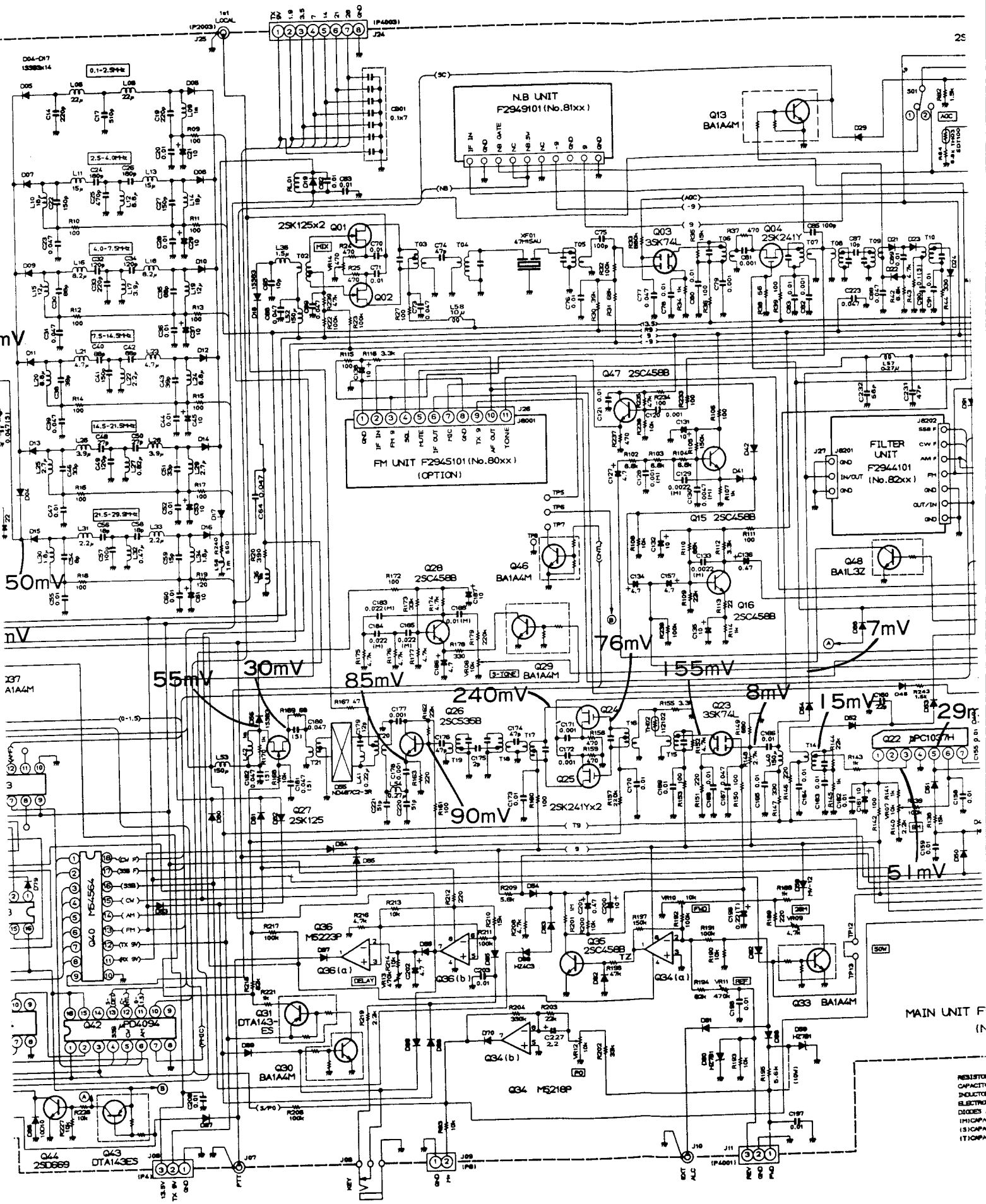

RESISTOR
CAPACITOR
INDUCTOR
ELECTROLYTIC
DIODE
INTEGRATED CIRCUIT
SYMBOL

LEVEL DIAGRAM

RECEIVE

For Service Manuals Contact
MAURITRON TECHNICAL SERVICES
 8 Cherry Tree Rd, Chinnor
 Oxon OX9 4GJ
 Tel: 01844-351694 Fax: 01844-352554
 Email: enquiries@mauritron.co.uk

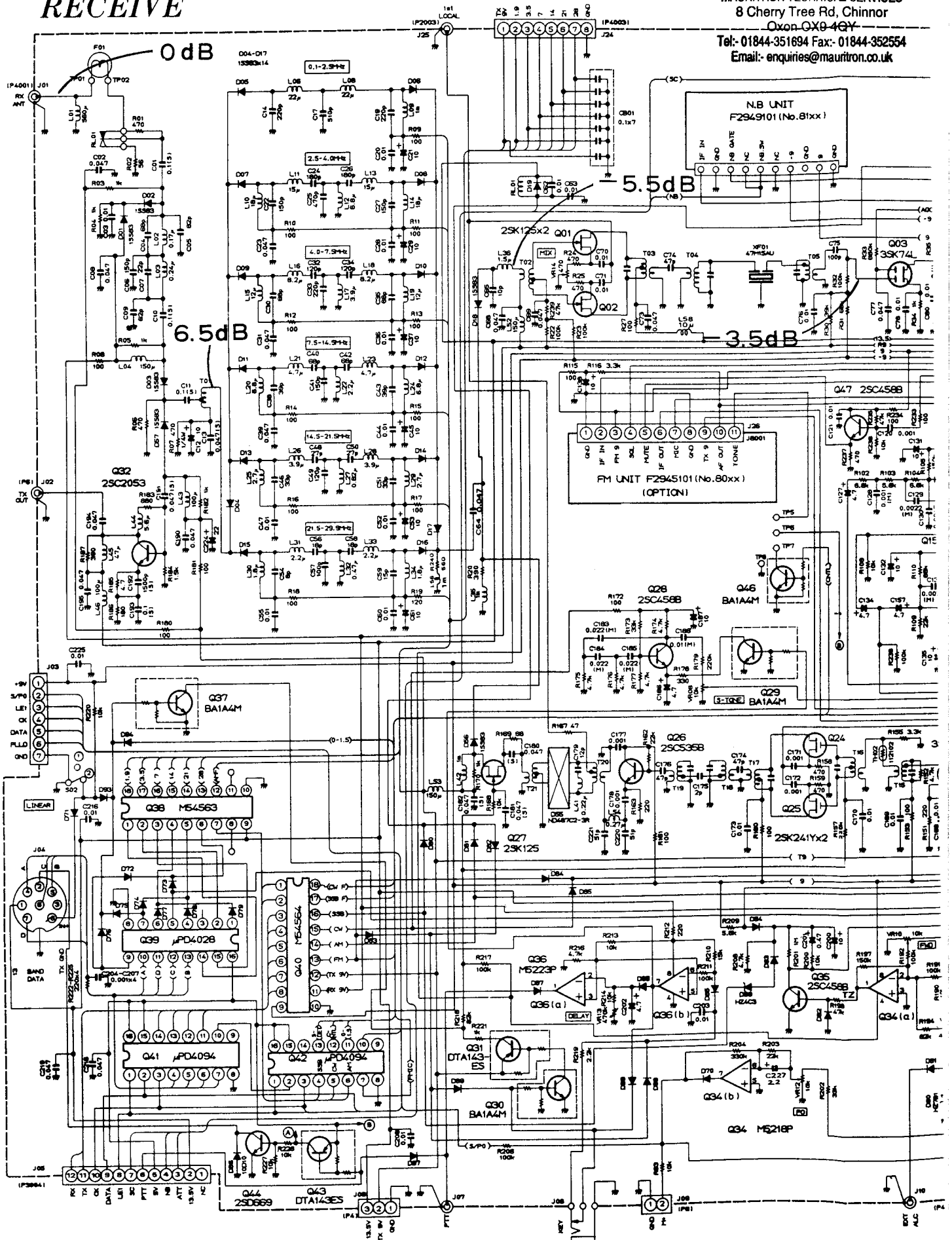

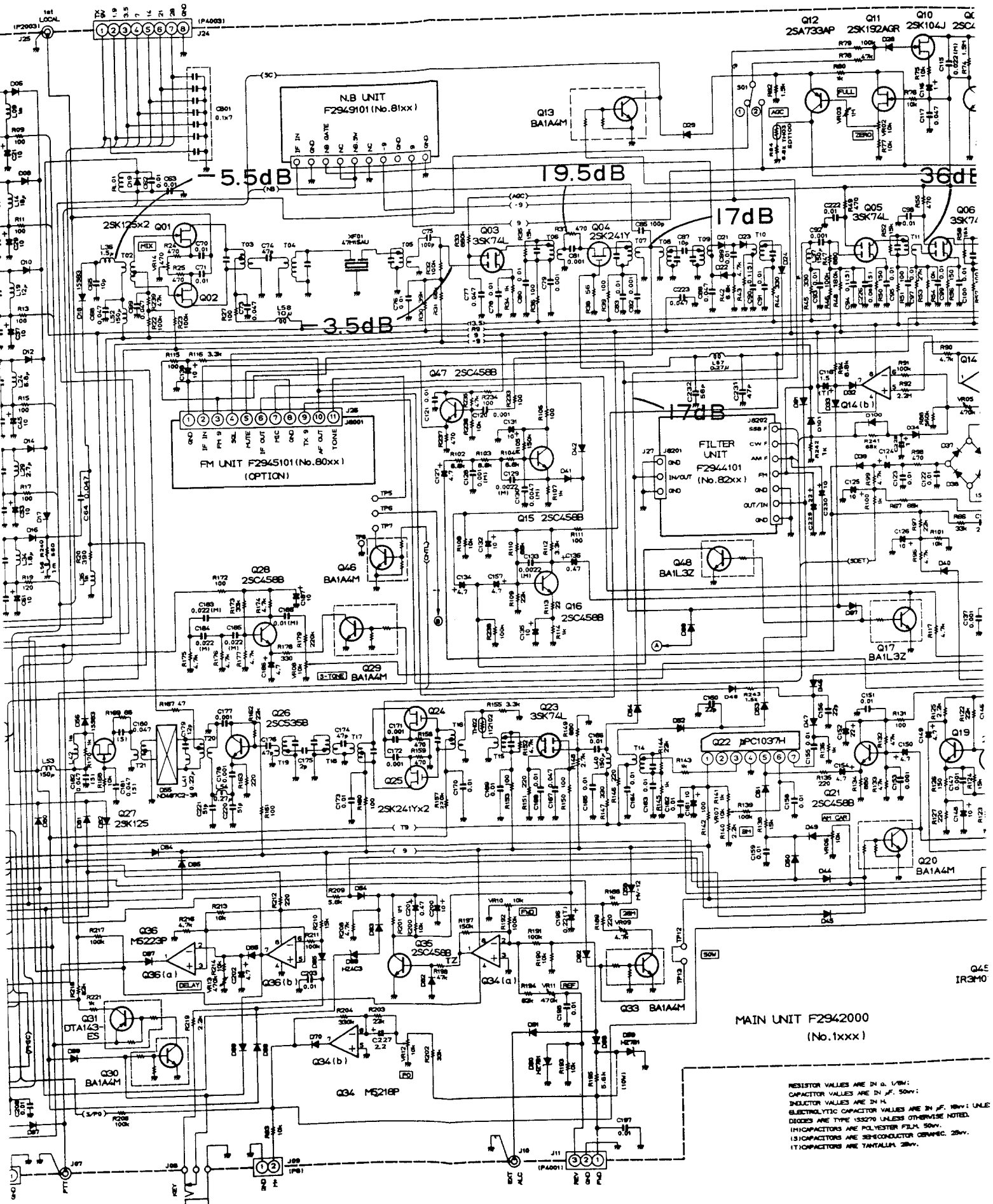

RESISTOR VALUES ARE IN Ω , $k\Omega$, $M\Omega$.
 CAPACITOR VALUES ARE IN pF , $50nF$.
 INDUCTOR VALUES ARE IN μH .
 ELECTROLYTIC CAPACITOR VALUES ARE IN μF , $10mF$ UNLESS NOTED.
 DIODES ARE TYPE 1N4001 UNLESS OTHERWISE NOTED.
 1N1 CAPACITORS ARE POLYESTER FILM, 50V.
 1S1 CAPACITORS ARE SILICON DIODE, 50V.
 1T1 CAPACITORS ARE TANTALUM, 35V.

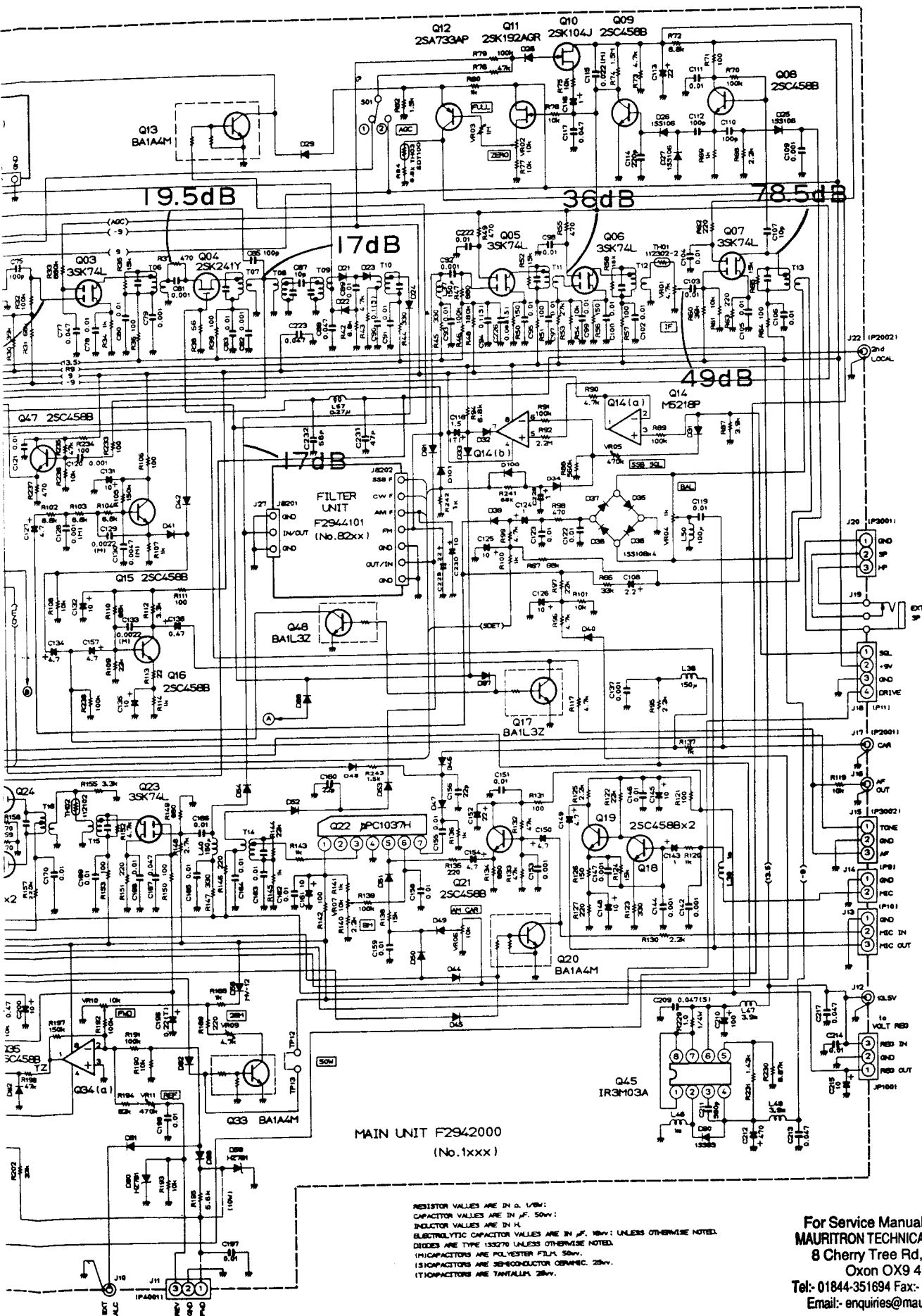

MAIN UNIT F2942000
(No. 1xxx)

RESISTOR VALUES ARE IN Ω , $\text{k}\Omega$, $\text{M}\Omega$.
 CAPACITOR VALUES ARE IN μF , 50pF .
 INDUCTOR VALUES ARE IN μH .
 ELECTROLYTIC CAPACITOR VALUES ARE IN μF , 10mV , UNLESS OTHERWISE NOTED.
 DIODES ARE TYPE 1N4001 UNLESS OTHERWISE NOTED.
 (1) CAPACITORS ARE POLYESTER FILM, 50V .
 (2) CAPACITORS ARE SEMICONDUCTOR CERAMIC, 25V .
 (3) CAPACITORS ARE TANTALUM, 25V .

For Service Manuals Contact
MAURITRON TECHNICAL SERVICES
 8 Chery Tree Rd, Chinnor
 Oxon OX9 4QY
 Tel: 01844-351694 Fax: 01844-352554
 Email: enquiries@mauritron.co.uk

FM UNIT (OPTION)

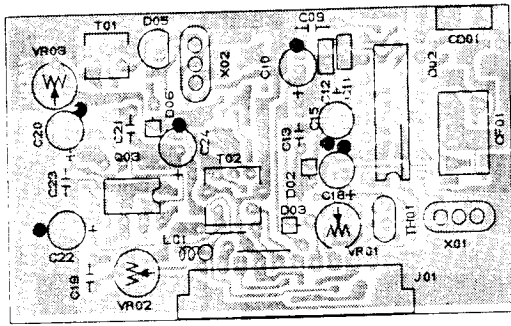

Component side (obverse)

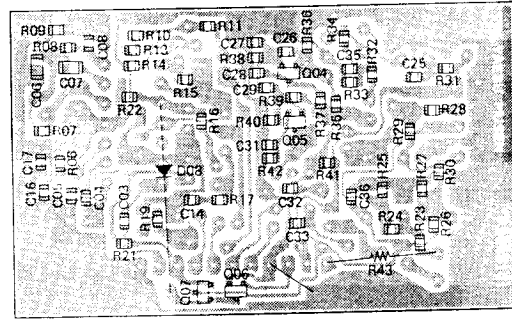

Solder side (reverse)

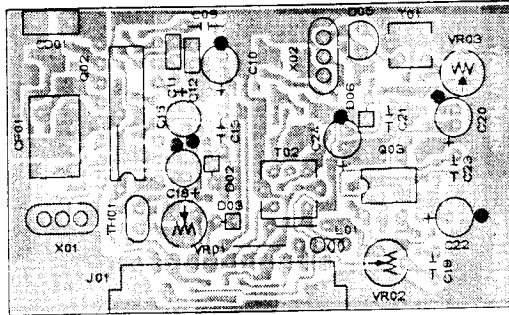

Component side (reverse)

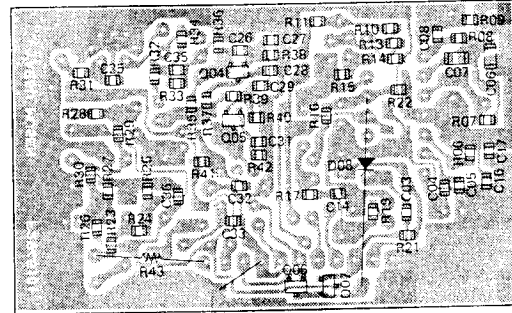

Solder side (obverse)

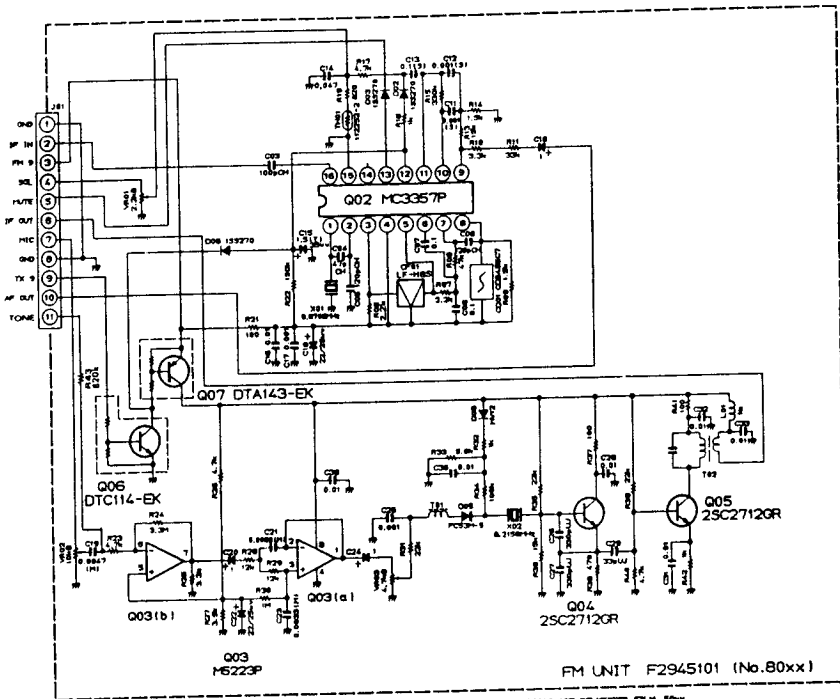

RESISTOR VALUES ARE IN Ω , μ OR k .
 CAPACITOR VALUES ARE IN μ F, n OR p .
 INDUCTOR VALUES ARE IN μ H.
 ELECTROLYTIC CAPACITOR VALUES ARE IN μ F, 100V.
 UNLESS OTHERWISE NOTED.

(1) CAPACITORS ARE POLYESTER FILM, 50V.
 (2) CAPACITORS ARE TANTALUM, 100V.
 (3) CAPACITORS ARE SEMICONDUCTOR CERAMIC, 25V.

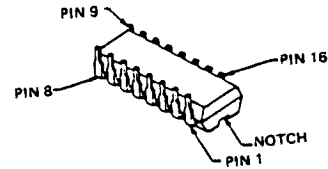

M03357P (Q8002)

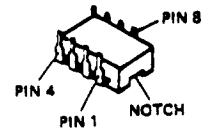

M5223P (Q8003)

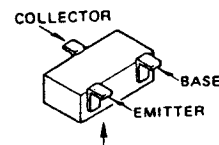

Marked Surface

- 2SC2712GR (LG) (Q8004,8005)
- DTA143-EK (33) (Q8007)
- DTC114-EK (Q8006)

For Service Manuals Contact
MAURITRON TECHNICAL SERVICES
 8 Cherry Tree Rd, Chinnor
 Oxon OX9 4QY
 Tel:- 01844-351694 Fax:- 01844-352554
 Email:- enquiries@maurifron.co.uk

INSTALLATION OF OPTIONS

Optional TCXO Installation

Optimum stability can be obtained with the FT-80C by installing the TCXO (Temperature Compensated Crystal Oscillator) in place of PLL reference crystal X1004 on the Local Unit.

- (1) Referring to Figure 1, slide the Local Unit upwards to remove it from the Main Unit and provide free access to both sides of the board.
- (2) Unsolder and remove trimmer TC1004, crystal X1004 and capacitors C1104 and C1105 (Figure 2). Use a vacuum solder remover or solder wick to clean away solder from around the holes under the TXCO mounting location.
- (3) Install the TXCO Unit as shown in Figure 3, and solder the TCXO case at points A (2 places), and solder the TCXO leads at B (3 places). Then trim the leads, and reinstall the Local Unit.

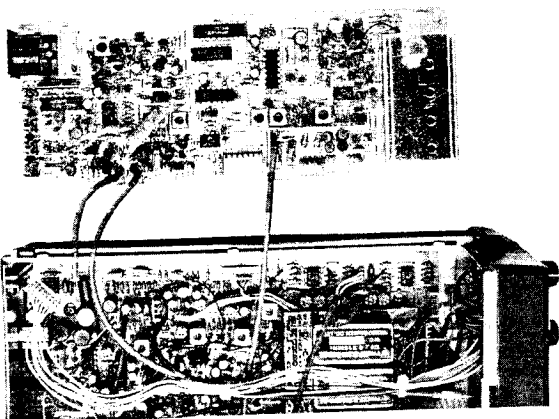

Figure 1

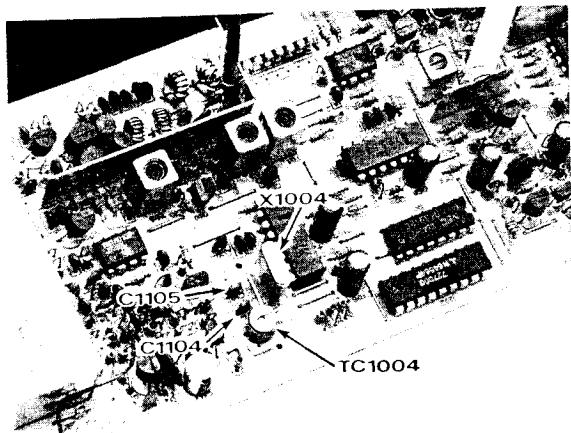

Figure 2

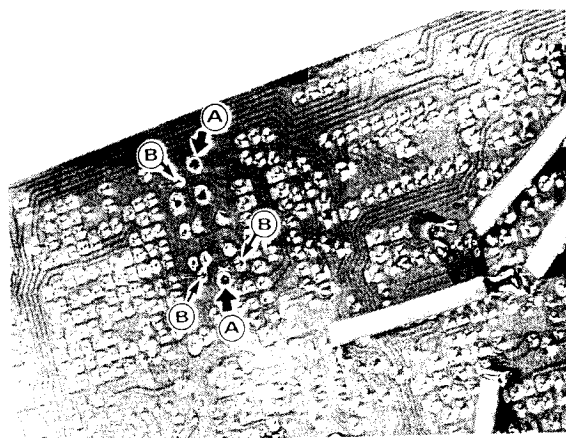

Figure 3

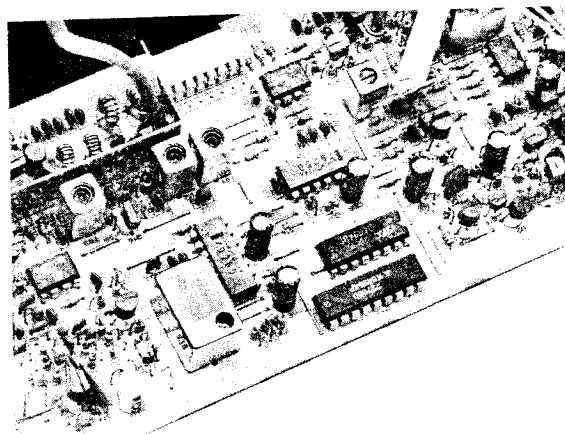
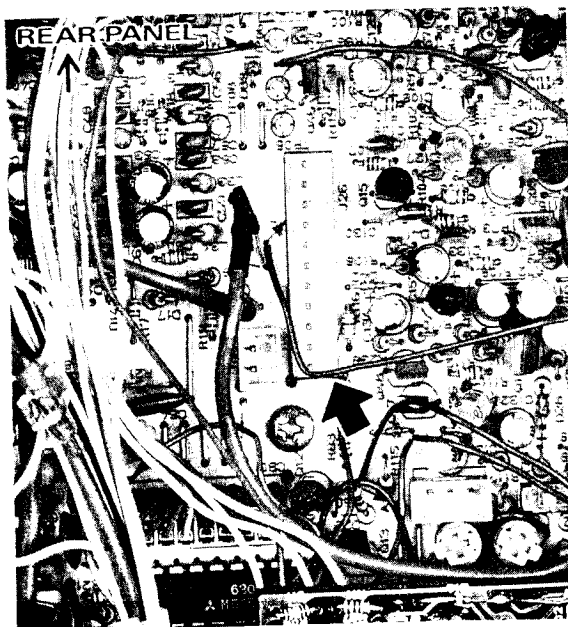

Figure 4

Optional FM Unit Installation

The optional FM Unit can be installed in the 11-pin jack shown in the photo below, with the component side of the board facing to the left.



SIGNAL PATH

SSB MODE

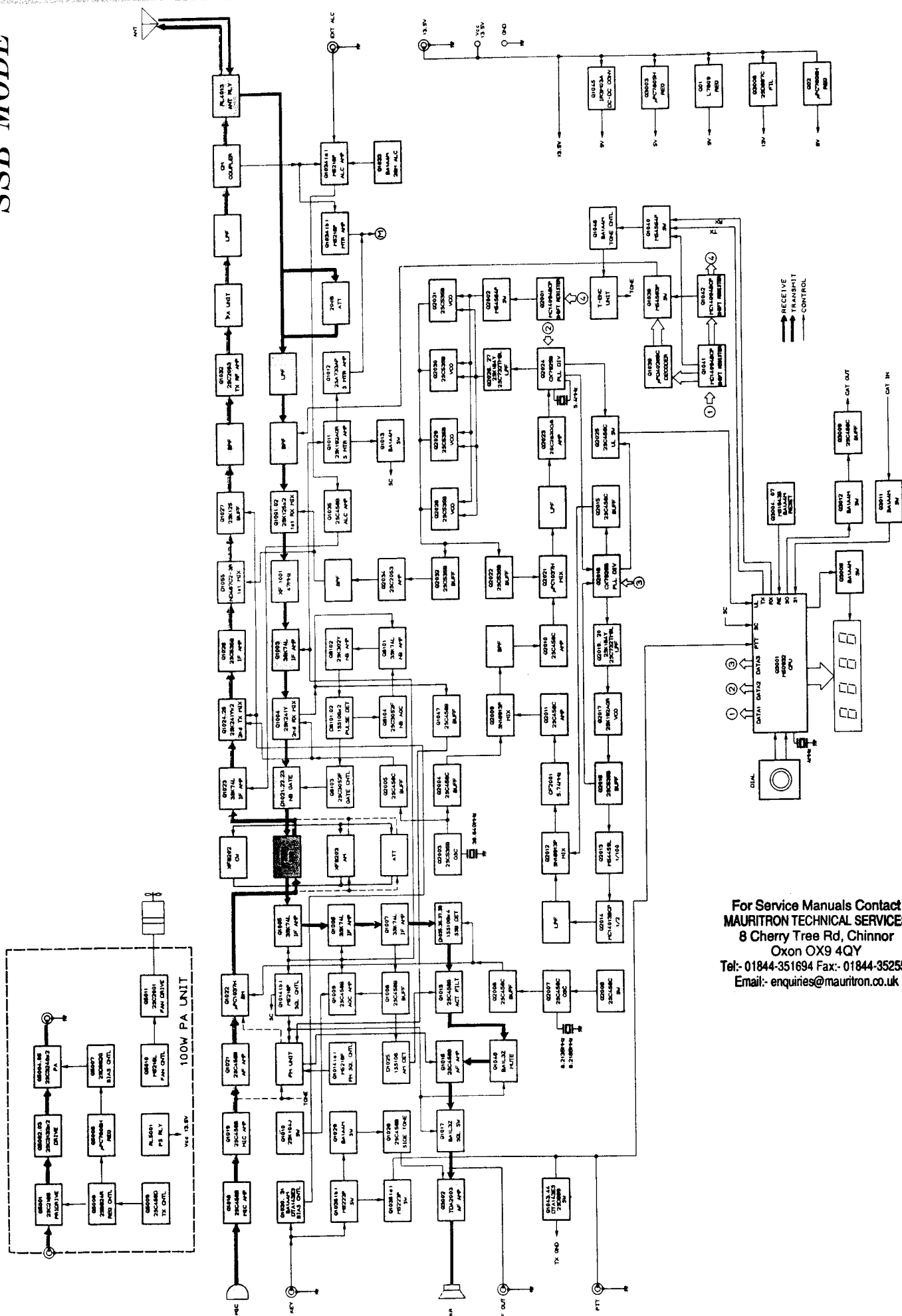

For Service Manuals Contact
MAURITRON TECHNICAL SERVICES
 8 Cherry Tree Rd, Chinnor
 Oxon OX9 4QY
 Tel: 01844-351694 Fax: 01844-352554
 Email: enquiries@mauritron.co.uk

SIGNAL PATH

CW MODE

For Service Manuals Contact
MAURITRON TECHNICAL SERVICES
 8 Cherry Tree Rd, Chinnor
 Oxon OX9 4QY
 Tel:- 01844-351694 Fax:- 01844-352554
 Email:- enquiries@mauritron.co.uk

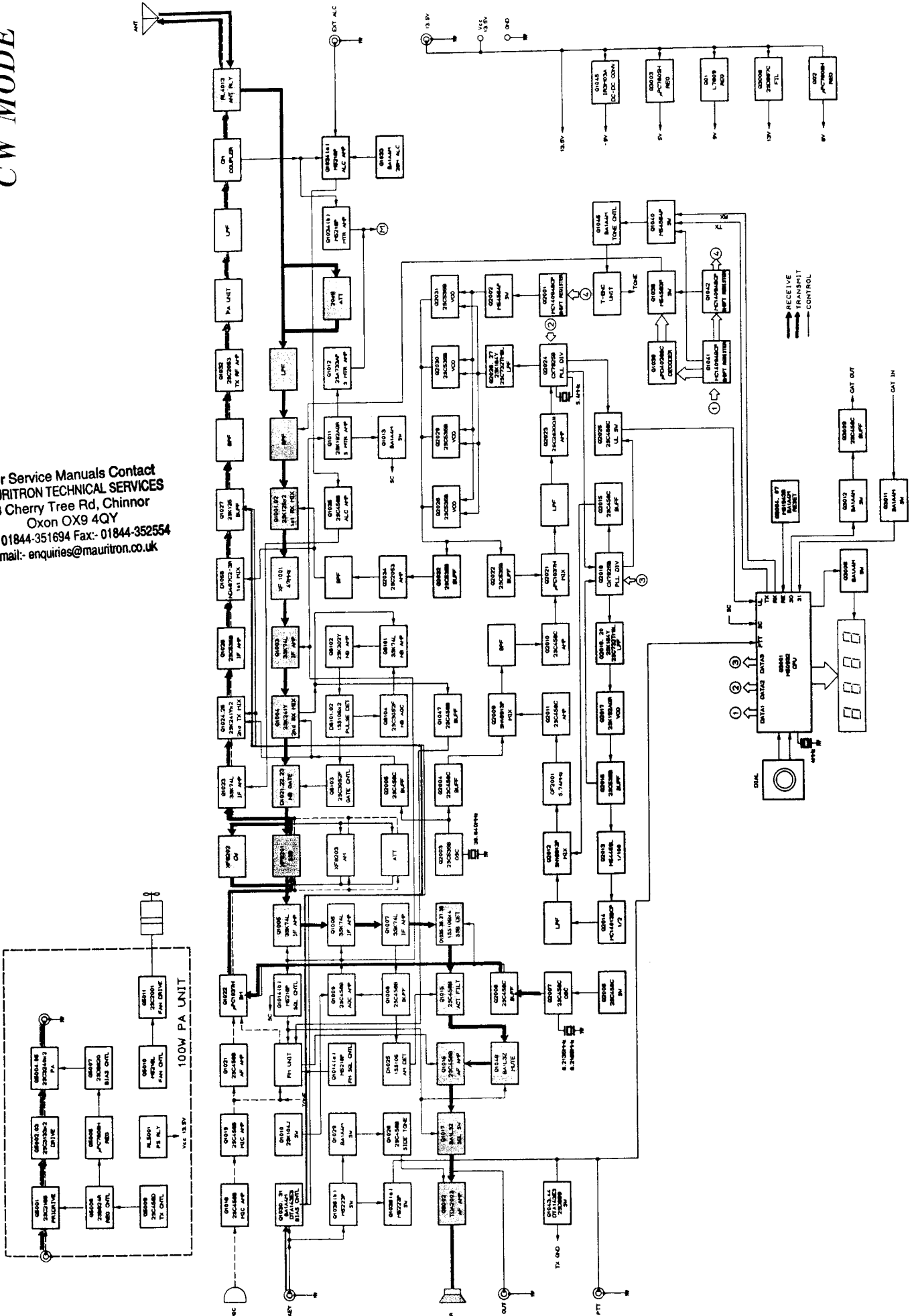

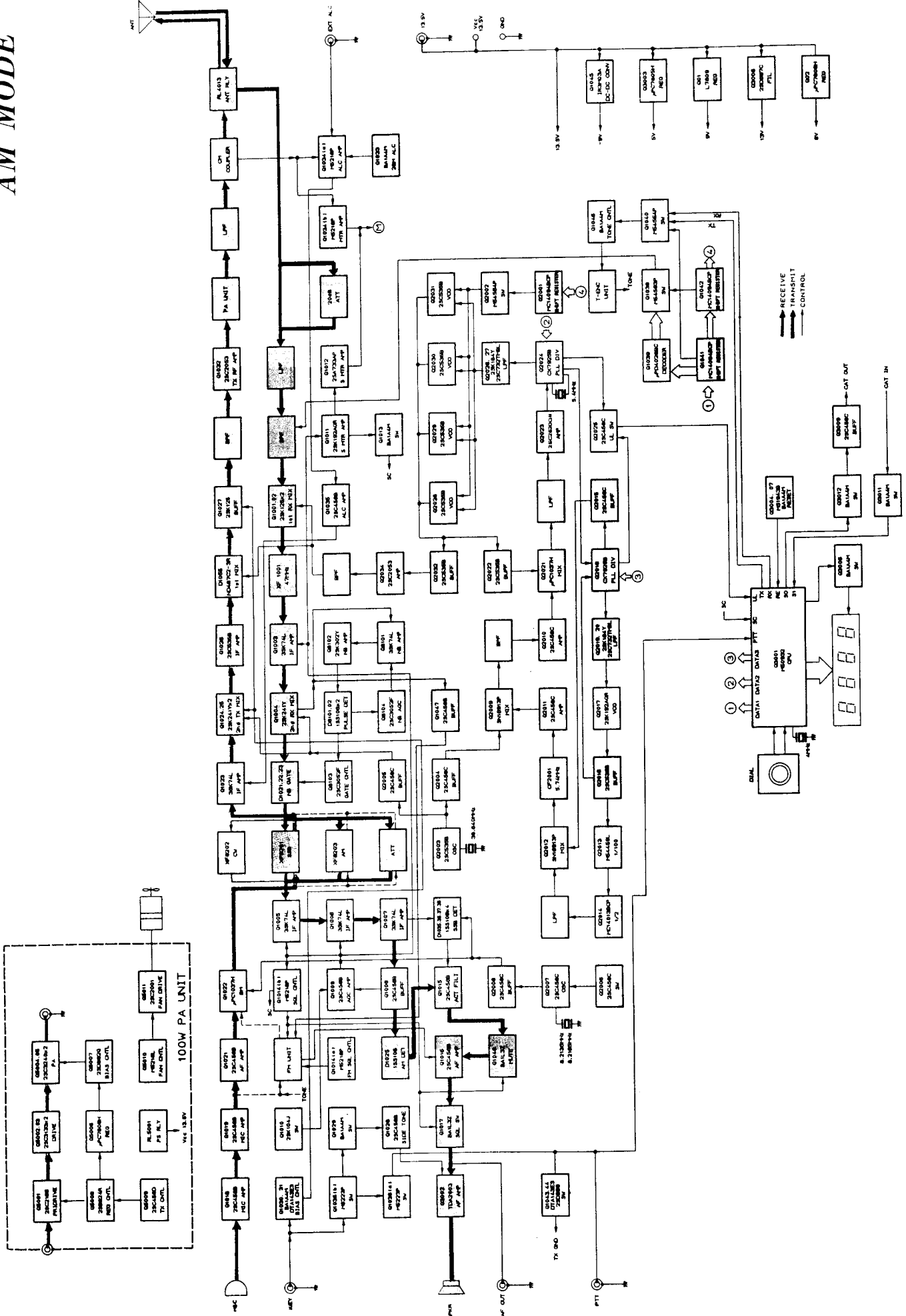

Refer to the block diagrams along with this description for an overall function description of the transceiver. For finer details, refer to the schematic diagrams.

RECEIVER

The RF input signal from the antenna jack is fed through t/r relay RL4013 on the LPF Unit before delivery to J1001 on the RF Unit.

The signal passes through lamp fuse F1001 and then a low-pass filter, followed by one of six bandpass filters, and is then fed to single balanced active mixer Q1001/Q1002 (2 x 2SK125), where the RF signal is mixed with the 1st local signal delivered from Q2034 (2SC2053) on the Local Unit, resulting in a 47.055 MHz 1st IF signal. This signal passes through 15 kHz BW monolithic crystal filter XF1001 (47M15AU) to strip away unwanted mixer products, and is then amplified by Q1003 (3SK74L).

The amplified 1st IF signal is applied to 2nd mixer Q1004 (2SK241Y), where it is mixed with the 38.8 MHz 2nd local signal delivered from buffer Q2005 (2SC458C) on the Local Unit, resulting in an 8.215 MHz 2nd IF signal. This signal passes through noise blanker gate D1021-1023 (3 x 1SS270) to one of three crystal filters for LSB/USB, CW or AM mode on the Filter Unit, for final IF passband definition. The filtered 2nd IF signal is amplified in three stages by Q1005-1007 (3SK74L) to a level sufficient to drive the detectors.

In CW and SSB modes, the 2nd IF signal from Q1007 is applied to product detector diode ring D1035-1038 (4 x 1SS270), which also receives an 8.2 MHz carrier signal from crystal oscillator Q2006 via buffers Q2007 and Q2008 (3 x 2SC458C) on the Local Unit. The frequency of the carrier oscillator is offset ± 1.5 kHz from the 2nd IF frequency according to the sideband of the selected mode.

In AM mode, the 2nd IF signal from Q1007 is further amplified by buffer amplifier Q1008 (2SC458B) before application to AM detector diode D1025 (1SS106).

The audio signal from the selected detector is passed through active lowpass filter Q1015 (2SC458B), which eliminates high-pitched noise on the audio signal, and amplified by AF preamplifier Q1016 (2SC458B). The audio signal is then delivered to the Display Unit, passed through front panel AF potentiometer VR1b and back to audio amplifier Q3002 (TDA2003H) on the Display Unit before final delivery via the PHONES jack to the loudspeaker or headphones.

In SSB, CW and AM modes, automatic gain control (AGC) voltage is derived from a portion of the output of buffer Q1008, rectified by D1026/-D1027 (2 x 1SS106) to provide a fluctuating DC voltage. This is amplified by Q1009 (2SC458B) and fed to the 2nd gates of IF amplifiers Q1003, Q1005 and Q1006 to reduce their gain when strong signals are present in the receiver passband, and is also delivered to S-meter buffer Q1011 (2SK-192AGR) and amplifier Q1012 (2SA733AP) to drive the front panel S-meter.

To provide squelch control in SSB, CW and AM modes, a sample of the AGC signal is applied to comparator op amp Q1014(b) ($\frac{1}{2}$ M5218P), along with a DC bias set by SQL potentiometer VR1a on the front panel. When the AGC level is below the threshold set by the squelch control, Q1014(b) turns on squelch switch Q1048 and mute switch Q1017 (both BA1L3Z), which remove input and output, respectively, from AF preamplifier Q1016.

When the noise blanker is enabled and pulse-type noise is received, a sample of the 2nd IF signal from Q1004 is delivered to NB Unit, where it is buffered and amplified by Q8101 (3SK74L) and Q8102 (2SK302Y) before application to pulse detector D8101/D8102 (2 x 1SS106). The resulting DC pulse switches noise blanker gate controller Q8103 (2SC3052F), which interrupts the 2nd IF signal at noise blanker gate D1021-1023 on the Main Unit during the length of the noise pulse. The DC voltage from the pulse detector is also amplified by Q8104 (2SC3052F) and fed back to gate 2 of Q8101 as noise blanker AGC.

When the optional FM Unit is installed, The 2nd IF signal from Q1004 is delivered through buffer amplifier Q1047 (2SC458B) to FM receiver sub-

CIRCUIT DESCRIPTION

system IC Q8002 (MC3357P) on the FM Unit, which consists of local oscillator, mixer, IF limiter amplifier and FM detector stages. The amplified 2nd IF signal is applied to the mixer section, along with the 3rd local signal produced by 8.6708 MHz crystal X8001. The 455 kHz product is then passed through ceramic filter CF8001 (LF-H8S), and returned to Q8002 for 3rd IF amplification and limiting to remove amplitude variations before detection by ceramic discriminator CD8001 (CDB455C7). Audio output from the FM IC is then de-emphasized by C8010 and R8011, and returned to AF preamplifier Q1016 on the Main Unit for audio amplification as already described for the other modes.

For FM squelch control, a bias voltage adjustable by the front panel SQL potentiometer is produced by op amp Q1014a ($\frac{1}{2}$ -M5218P) on the Main Unit, and delivered to FM IC Q8002 on the FM Unit. The FM IC uses this bias in combination with a sample of audio output of the detector stage to produce a DC squelch switching voltage whenever high frequency noise appears at the detector (as occurs when no carrier is present in the 3rd IF). This "mute" signal is returned to the Main Unit to disable the AF preamplifier via Q1048 and Q1017 as previously described for the other modes, and also to disable the S-meter via switch Q1013 (BA1A4M).

TRANSMITTER

For voice modes, audio from the microphone is delivered to the Main Unit at J1013 pin 2, and amplified by Q1018/Q1019 (2 x 2SC458B). For SSB and AM modes, the amplified speech audio is then passed through MIC gain potentiometer VR2b on the front panel, and further amplified by Q1021 (2SC458B) before application to balanced modulator Q1022 (uPC1037H). The modulator also receives a carrier signal from the carrier oscillator on the Local Unit. The resulting 8.2 MHz double sideband product from the modulator is delivered to the Filter Unit, where, for SSB modes, the unwanted sideband is stripped by crystal filter XF8201 (XF8.2M-242-02). In AM mode, the double sideband signal is merely attenuated by the same amount as the filter's insertion loss. The resulting 8.2 MHz single sideband signal (for LSB or USB) or double sideband signal (for AM) is buffered by

Q1023 (3SK74L) and then applied to single balanced mixer Q1024/Q1025 (2 x 2SK241Y), which also receives the 38.8 MHz local signal from the Local Unit. The resulting 47 MHz IF signal is filtered and then amplified by Q1026 (2SC535B) before application to double balanced mixer ring D1055 (ND487C2-3R), where it is mixed with the PLL local signal from Q2034 on the Local Unit. The resulting RF signal at the transmit frequency is amplified by Q1027 (2SK125) and filtered by one of six bandpass filters to suppress out-of-band mixer products. The RF signal is then amplified up to 200 mV by Q1032 (2SC2053), and delivered to the 100W PA Unit.

On the 100W PA Unit, the low-level RF signal from the Main Unit is amplified by pre-driver Q5001 (2SC2166), push-pull driver Q5002/Q5003 (2 x 2SC3133), and then push-pull final amplifier Q5004/Q5005 (2 x 2SC3240), which provides approximately 100 watts of RF output for delivery to the LPF Unit.

On the LPF Unit, RF output from the final amplifier is passed through one of six lowpass filters, a sampling directional coupler, and t/r RL4013 before delivery to the antenna jack. The sampling directional coupler senses forward and reverse power output, which is rectified by D4003 (1SS106) and D4002 (1SS270), respectively, for return to the ALC and SWR sensing circuitry on the Main Unit. The DC voltages derived from forward and reverse power are applied in combination to op amp Q1034(a) ($\frac{1}{2}$ -M5218P), the output of which is buffered by Q1035 (2SC458B) and fed back to the 2nd gate of the transmitter chain's 8.2 MHz IF amplifier Q1023, so that transmitter IF gain is regulated by relative power output, thus preventing overdrive or transmission into an excessive impedance mismatch at the antenna. Detected forward power is also applied to ALC meter driver op amp Q1034(b) ($\frac{1}{2}$ -M5218P) for ALC indication on the panel meter during transmission.

For CW (A1) mode transmission, the PTT line is controlled by the telegraph key, after pulse shaping and delay by dual op amp Q1036 (M5223P). Mode selector Q1040 (M54564) disables speech input to modulator Q1022 by Q1020 (BA1A4M), and enables sidetone audio oscillator Q1028 (2SC458B), which is in turn keyed by

For Service Manuals Contact
MAURITRON TECHNICAL SERVICES
8 Cherry Tree Rd, Chinnor
Oxon OX9 4QY
Tel: 01844-351694 Fax: 01844-352554
Email: enquiries@mauritron.co.uk

Q1036 via Q1029 (**BA1A4M**). The resulting keyed audio from the sidetone oscillator is delivered to the audio amplifier on the Display Unit, and then via the PHONE jack to the loudspeaker or headphones. Meanwhile, on the Local Unit, serial mode selection data from the Main Unit activates Q2006 (**2SC458B**) to shift the frequency of USB carrier oscillator crystal X2002, so that the carrier signal delivered to balanced modulator Q1022 on the Main Unit passes unhindered through crystal filter XF8201 on the Filter Unit. The carrier is then mixed to the final transmitting frequency and amplified as described previously for the other modes.

When the optional FM Unit is installed, amplified speech audio from microphone amplifier Q1018/-Q1019 is delivered to IDC (instantaneous deviation control) amplifier Q8003(b) ($\frac{1}{2}$ **M5223P**) on the FM Unit, which prevents overdeviation from excessive microphone levels, and is then pre-emphasized and lowpass filtered by Q8003(a), C8021, R8028 and R8029 to suppress out-of-band modulation. The processed audio applied to varactor diode D8005 (**FC53M-5**) to modulate FM carrier VCO Q8004 (**2SC2712GR**), which has a center frequency of 8.2158MHz. The modulated carrier is buffered by Q8005 (**2SC2712GR**) and returned to modulator IC Q1022 on the Main Unit, which has its other input port disabled during FM transmission, so that the 8.2 MHz carrier is passed through for amplification in the same manner as for other modes.

PLL

The PLL local signal for the receiver 1st local and the transmitter final local is generated by one of four VCOs: Q2028-Q2031 (all **2SC535B**) in conjunction with varactors D2008, D2011, D2013 and D2015 (all **1SV55**). The oscillating frequency is determined primarily by the level of DC voltage applied to the varactors. VCO output is buffered by Q2032 (**2SC535B**, amplified by Q2034 (**2SC2053**) and band-pass filtered by C2148-C2153 and L2014-L2017 before delivery to TX mixer D1055 and RX 1st mixer Q1001/Q1002 on the Main Unit. A sample of the output of the selected VCO is also buffered by Q2022 (**2SC535B**) and delivered to MIX BPF Unit for application to PLL mixer Q7021 (**uPC1037H**), where the sample VCO signal is mixed with a 44.5 MHz PLL local signal

delivered from PLL local VCO Q2010 (**2SC458C**), resulting in a 2.6-32.45 MHz PLL IF signal. This signal is band-pass filtered by T7010-T7014, C7088-C7097 and C7158, amplified by Q7023 (**2SC2620QB**) and returned to the Local Unit for application to the programmable divider section of PLL subsystem IC Q2024 (**CX7925B**), which also includes a reference oscillator/divider and phase detector. The programmable divider section of Q2024 divides the PLL IF signal down to 50 kHz, according to serial frequency data from microcontroller Q3001 (**M50932**) on the Display Unit.

The reference oscillator/divider section of Q2024 generates another 50 kHz reference signal by dividing the signal from 5.4 MHz crystal X2004 by 108. This 50 kHz reference and the 50 kHz signal derived from the PLL IF are applied together to the phase detector section of Q2024, which produces a DC pulse train with average power proportional to any phase difference between the two 50 kHz signals. The pulse train is then smoothed by loop filter Q2026/Q2027 (**2SK184Y/-2SC732TMBL**), producing a DC voltage at a level corresponding to the difference in phase between the divided reference and the VCO signal. This voltage is returned to the varactor diodes in the selected VCO tank circuit, phase locking the VCO to the reference crystal.

The PLL local signal is derived from PLL subloop VCO Q2017/D2005 (**2SK192AGR/FC-53M5**). the 63-72.995 MHz output of which is buffered by Q2016 (**2SC535B**) and then divided by 100 at Q2013 (**M54459L**) and again by 2 at Q2014 (**uPD4013BCP**). The 1/200 divided local signal is low-pass filtered by L2002, L2003 and C2047-C2051 and applied to 1st subloop mixer Q2012 (**SN16913P**), which also receives a 5.4 MHz signal from reference crystal X2004, through subloop PLL subsystem IC Q1018 (**CX7925B**), buffered by Q2015 (**2SC458C**). The 5.715-5.764975 MHz product of these signals is passed through ceramic filter CF2001 (**SFT5.74MA**), buffered by Q2011 (**2SC458C**), and applied to 2nd subloop mixer Q2009 (**SN16913P**) along with a 38.84 MHz signal from crystal oscillator Q2003 (**2SC535B**), buffered by Q2004 (**2SC458C**). The resulting 44.555-44.604975 MHz product is then band-pass filtered by T2001, T2002 and C2032, and buffered by Q2010 before delivery to PLL mixer Q7021 on the Mix BPF Unit.

CIRCUIT DESCRIPTION

A sample of the buffered 63-72.995 MHz output of the subloop VCO is fed to the programmable divider stage of subloop PLL subsystem IC Q2018 where it is divided down to 5 kHz according to serial data from microcontroller Q3001 on the Display Unit. Another 5 kHz signal is derived from 5.4 MHz crystal X2001, divided by 108 in the reference divider section of Q2018. The two 5 kHz signals are applied to the phase detector section of Q2018, and the resulting pulse train is smoothed by subloop filter Q2019/Q2020 (2SK184Y/2SC732TMBL), producing a DC voltage at a level corresponding to the difference in phase between the divided reference and the subloop VCO signals. This voltage is applied to D2005 in the tank circuit of the subloop VCO, phase locking the subloop VCO to crystal X2004.

PLL subsystem ICs Q2018 and Q2024 each provide an indication of whether the PLL is unlocked, at pin 8. These signals are ORed together to unlock switch Q2025, which signals mcu Q3001 on the Display Unit via the "UL" line to disable transmission as long as either loop is not phase-locked.

CONTROL CIRCUITRY

Major frequency control functions such as memory/vfo tuning, storage and display, and PLL divider control are performed by microcontroller Q3001 (M50932) on the Display Unit, at the command of the the user via the tuning knob and pushbutton switches on the front panel. Serial data from the mcu is delivered to Main and Local Units via the CK, DATA and LE lines.

On the Main Unit, serial data for the PLL dividers (on the Local Unit), bandpass filters and mode selection are decoded by shift registers Q1041 and Q1042 (uPD4094) and BCD-to-Decimal decoder Q1039 (uPD4028BC). The resulting binary outputs for bandpass filter selection are buffered and level-shifted by switch Q1038 (M54563), while those for transmit/receive and mode selection are buffered and level-shifted by Q1040 (M54564).

Mode and band selection serial data from the Main Unit is decoded by shift register Q2001 (uPD4094BCP) and level-shifted by Q2002 (M54564) to select the active main PLL VCO, and the carrier oscillator required for the selected

mode. Programmable divider data from the Display Unit is applied directly to PLL subsystem ICs Q2018 and Q2024.

4800-baud, TTL-level serial data I/O for external control of the transceiver via the CAT system is provided by mcu pin 24 (input) and 25 (output), accessible from the rear panel jack.

POWER SUPPLY & REGULATION

13.5V DC is supplied to J03 in the rear panel, and fed through power switch relay RL5001 on the 100W PA Unit to the 13.5V DC bus.

The +9V bus is derived from the 13.5V bus via regulator Q2 (uPC7808H) on the main chassis. The -9V bus for the opamps is derived from the 13.5V bus by DC-DC converter IC Q1045 (IR3M03A) on the Main Unit. The +9V bus is switched by Q1040 on the Main Unit, under control of the mcu via pins 41 and 42, to provide TX9V and RX9V buses for transmit/receive switches.

For Service Manuals Contact
MAURITRON TECHNICAL SERVICES
8 Cherry Tree Rd, Chinnor
Oxon OX9 4QY
Tel: 01844-351694 Fax: 01844-352554
Email: enquiries@mauritron.co.uk

Up to twenty channels in the FT-80C can be programmed with user-specified simplex or split frequencies and mode.

With the transceiver switched off, gently pry the plastic cover from the front panel (Figure 1). This will expose a set of holes giving access to switches underneath, which must be pushed using a sharp tool (such as a toothpick).

(Simplex Channels)

- 1) Switch the transceiver on, press the switch in hole **A** (Figure 2), if necessary, several times until "VFO A" is displayed.
- 2) Press the **◀MODE▶** button to select the desired mode for the new channel, and turn the Channel Selector Knob until the desired channel frequency is displayed (press the switch in hole **B** and immediately turn the Channel Selector Knob for 500 kHz tuning steps).
- 3) Press the switch in hole **C** (so that "MR" is displayed) and turn the Channel Selector Knob to select the memory channel number to be programmed.
- 4) Press the switch in hole **A** to return to the programming mode, and then press the switch in hole **E** to store the new frequency and mode data selected in step 2 into the memory channel selected in step 3.

When finished programming, press the switch in hole **C** to return to memory mode, and replace the plastic cover.

For Service Manuals Contact
MAURITRON TECHNICAL SERVICES
 8 Cherry Tree Rd, Chinnor
 Oxon OX9 4QY
 Tel: 01844-351694 Fax: 01844-352554
 Email: enquiries@mauritron.co.uk

(Semi-Duplex Channels)

- 1) For semi-duplex (split frequency) channels (Channel numbers 1 through 17 only), after performing steps (1) and (2) of the Simplex procedure for the transmitter, press the switch in hole **A** so that "VFO B" is displayed, and repeat the same step (2) for the receiver.
- 2) Press the switch in hole **D** to select split frequency operation (SPLIT is displayed), and then press the switch in hole **E** to store both transmit and receive frequencies into the memory channel.

When finished programming, press the switch in hole **C** to return to memory mode, and replace the plastic cover.

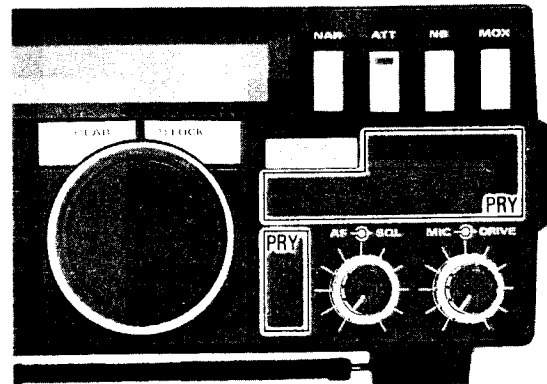

Figure 1

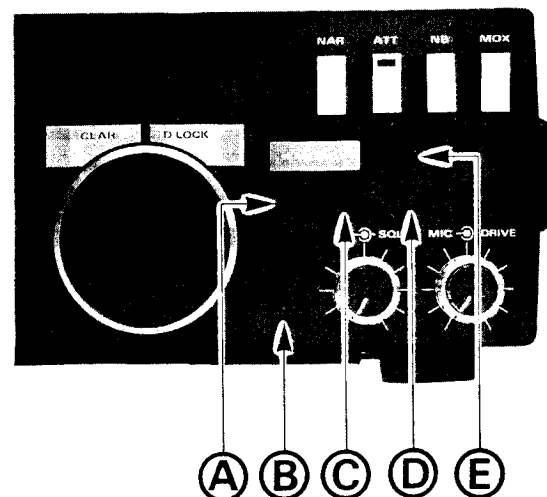

Figure 2

NOTE

**For Service Manuals Contact
MAURITRON TECHNICAL SERVICES
8 Cherry Tree Rd, Chinnor
Oxon OX9 4QY
Tel:- 01844-351694 Fax:- 01844-352554
Email:- enquiries@mauritron.co.uk**

ALIGNMENT NOTES

Service and alignment should be performed only by qualified service personnel, using the proper test equipment as listed below. Warranty claims may be invalidated by unauthorized service attempts.

During alignment, the NAR, ATT and NB buttons should be set to OFF, and the SQL control must be fully counterclockwise, except where specifically stated otherwise. A 50-ohm dummy load must be connected to the antenna jack in all steps calling for transmission (pressing the MOX button). Correct alignment is not possible using an antenna.

To select the frequencies required for alignment, follow steps 1 and 2 of the Channel Programming procedure (for Simplex Channels) on page 27, which will allow you to tune the transceiver with the channel selection knob.

In the following procedures, after completing one step, read the following step to determine whether the same test equipment will be required. If not, remove the test equipment (except the dummy load and wattmeter, if connected) before proceeding.

For Service Manuals Contact
MAURITRON TECHNICAL SERVICES
 8 Cherry Tree Rd, Chinnor
 Oxon OX9 4QY
 Tel: 01844-351694 Fax: 01844-352554
 Email: enquiries@mauratron.co.uk

SPECIFICATIONS

GENERAL	TRANSMITTER	RECEIVER
Frequency range 1.5-29.999975 MHz, except 7.6-9 MHz and 23.527 ±50 kHz	Emission types LSB, USB (J3E); CW (A1A); AM (A3E) and optionally FM (F3E)	Circuit type CW, SSB, AM: double conversion FM*: triple conversion
Number of channels 20	Power output (+20/-10%) SSB, CW & FM*: 100W PEP/DC, AM: 25W Carrier	Clarifier range ±9.975 kHz
Channel steps SSB & CW: 25 Hz AM: 1 kHz FM*: 5 kHz	SSB Carrier suppression better than 40dB below peak output	Sensitivity (for 10dB S+N/N, exc FM) SSB/CW: 0.5uV AM: 2uV FM*: 0.7uV for 12dB SINAD (above 28MHz)
Frequency stability (0° to +40°C) SSB, CW, AM: ±200 Hz FM: ±300 Hz	Unwanted sideband suppression (SSB) better than 50dB (1 kHz tone)	Squelch sensitivity SSB/CW/AM: 2.0uV above 1.5 MHz, 4.0uV within 0.5-1.5 MHz FM*: 0.32uV
Frequency accuracy SSB, CW, AM: ±200 Hz FM: ±300 Hz	Spurious radiation Harmonic: better than -46dB (within 1.8-2.5, 3-3.5, 5.5-8, 10-15 and 18-30 MHz) Non-Harmonic: better than -40dB	Intermediate frequencies 47.055MHz, 8.215MHz, 455kHz(FM-only*)
Antenna impedance (nominal) 50 ohms, unbalanced	Audio response less than -6dB from 400 to 2600Hz	Image rejection better than 70dB within 1.5-30MHz
Supply voltage 13.5 V DC ±10% (neg. ground)	3rd order intermodulation distortion better than -25dB (@100W PEP)	IF rejection better than 60dB within 1.5-30MHz
Maximum current consumption 19A (typical, @100W output)	Modulation systems SSB/CW: active balanced modulator AM: early stage (low level) FM*: variable reactance	Selectivity (-6/-60dB) SSB, CW(W), AM(N): 2.2/5 kHz CW(N): 500 Hz/1.8 kHz AM(W): 6/14 kHz; FM(6/50dB)*: 8/19kHz
Dimensions (WHD) 238 x 93 x 238mm (without knobs)	Maximum FM* deviation ±2.5 kHz	Maximum audio power output at least 1.5W into 8 ohms w/10% THD
Weight (approx) 3.5 kg (7.72 lb)	Microphone impedance 500 to 600 ohms	Audio output impedance 4 to 8 ohms

* FM operation requires optional unit.

Specifications may be subject to change without notice or obligation.

ALIGNMENT

Alignment Equipment

Frequency counter with accuracy of 0.1 ppm to 100 MHz

DC voltmeter with at least 10-Megohm input impedance

RF voltmeter with at least 5% accuracy to 100 MHz, high impedance, and ranging from 10 mV to 3 Vrms

AF millivoltmeter

DC milliammeter ranging to 500 mA

RF in-line wattmeter

Resistive dummy load, 50 ohms, 150W; three required for SWR Turndown alignment

RF signal generator covering 1-30 MHz, with calibrated output levels from 5 dB μ to 100 dB μ

AF signal generator with calibrated output levels from 1 mV to 25 mV

RF sampling coupler ("T")

Additional Alignment Precautions

Correct alignment requires that the ambient temperature be the same as that of the transceiver and test equipment, and that this temperature be held constant between 20 and 30 °C (68 to 86 °F). When the transceiver is brought into the shop from hot or cold air it should be allowed some time for thermal equalization before alignment.

Alignments must only be made with oscillator shields and circuit boards firmly affixed in place. Also, the test equipment must be thoroughly warmed up before beginning.

Alignment values assume a DC supply voltage of 13.5V DC.

Note: Signal levels in dB referred to in the alignment procedure are based on 0dBu=0.5uV.

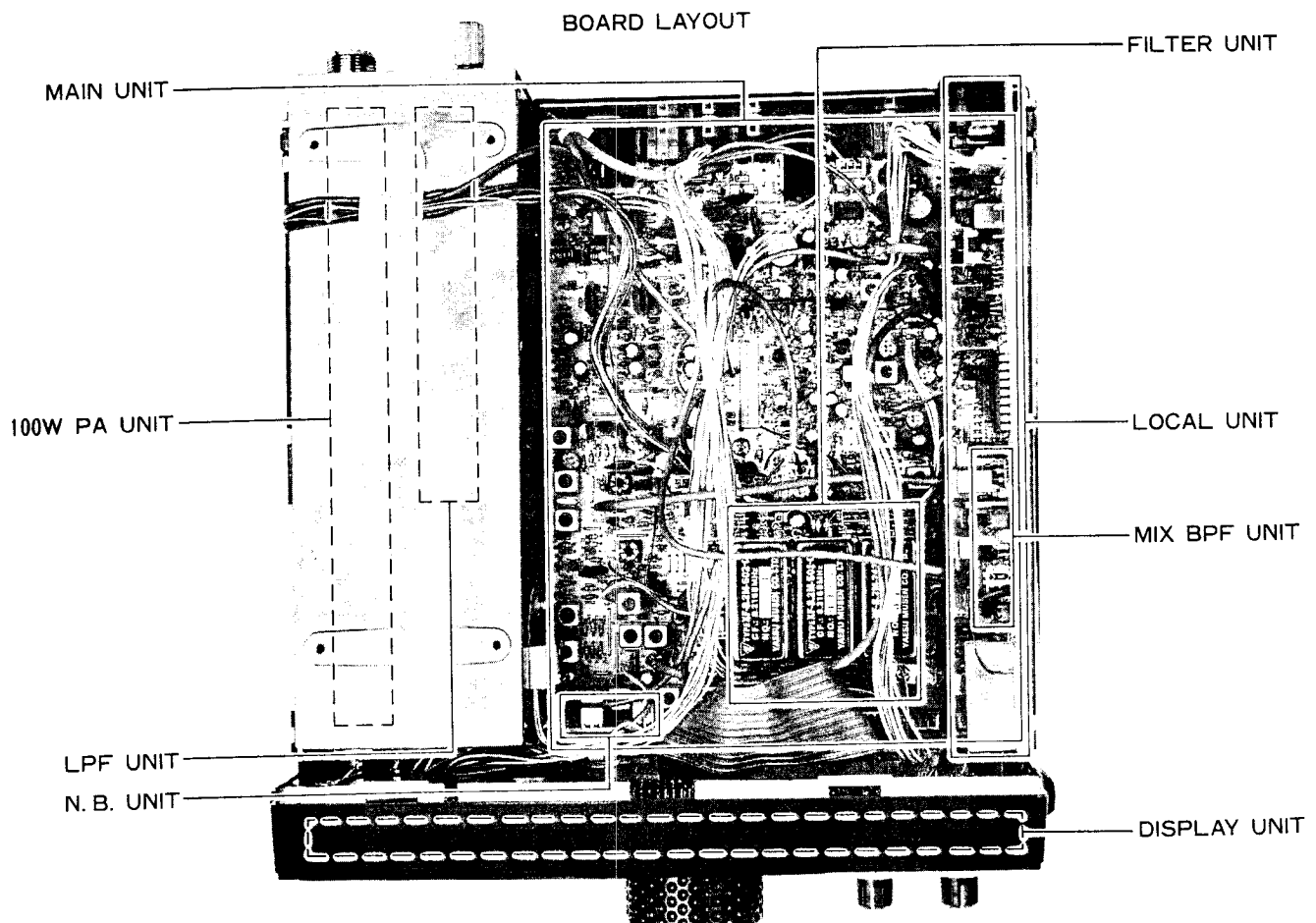

I. Local Unit

A. 2nd Local Overall Check

1. Disconnect TMP plug P2002 from J1022 on the Main Unit.
2. Connect the frequency counter to P2002 and confirm 38.8380 MHz \pm 400 Hz on the counter.
3. Remove the counter and connect a 50-ohm resistor and the RF voltmeter to P2002.
4. Confirm at least 230 mVrms on the voltmeter.
5. Disconnect the resistor and voltmeter, and replace P2002 in J1022.

B. PLL Subloop VCO

1. Connect the DC voltmeter between the exposed lead of R2058 (TP2001) and chassis ground.
2. Tune the transceiver to 7.0015 MHz, LSB mode.
3. Adjust T2005 for 2.0 \pm 0.1V on the meter.
4. Retune the transceiver to 7.0014 MHz and confirm at least 5.6 \pm 0.6V on the voltmeter.
5. Disconnect the voltmeter.

C. PLL Subloop BPF

1. Connect the RF voltmeter to the exposed lead of C2030 (TP2002).
2. Tune the transceiver to 7.0265 MHz, LSB mode.
3. Adjust T2004 for peak on the voltmeter (at least 70 mVrms).
4. Move the voltmeter to TP2003, and retune the transceiver to 7.0267 MHz.
5. Adjust T2001-T2003 for peak on the voltmeter (more than 50 mVrms).
6. Disconnect the voltmeter.

D. PLL Main Loop VCO

1. Connect the DC voltmeter between the exposed lead of R2083 (TP2004) and chassis ground.
2. Referring to the following table, tune the transceiver to each adjustment frequency (MHz), adjust the corresponding transformer for 1.5 \pm 0.1V, retune to the corresponding check frequency and confirm the check voltage on the voltmeter.

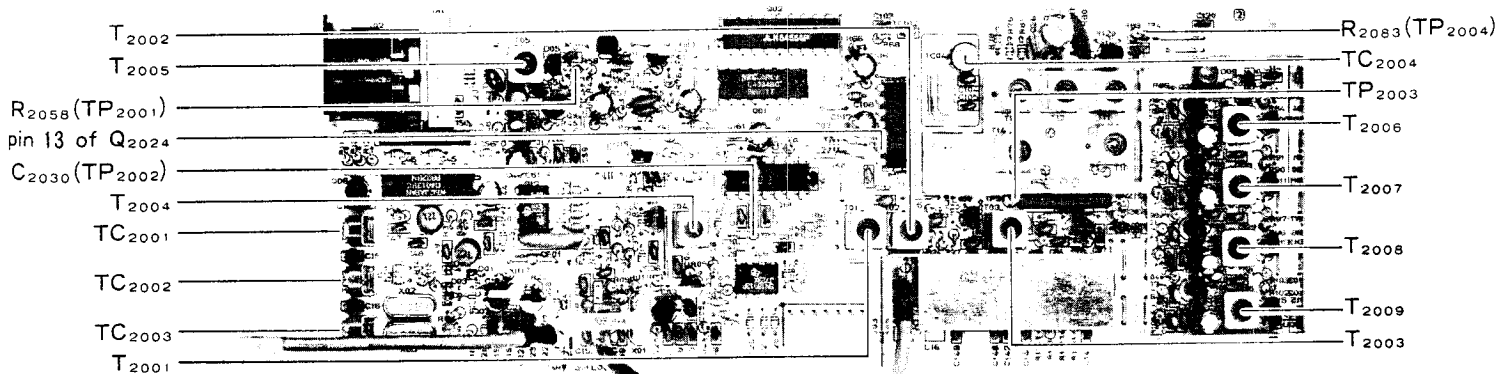

LOCAL UNIT ALIGNMENT POINTS

For Service Manuals Contact
MAURITRON TECHNICAL SERVICES
 8 Cherry Tree Rd, Chinnor
 Oxon OX9 4QY
 Tel: 01844-351694 Fax: 01844-352554
 Email: enquiries@mauritron.co.uk

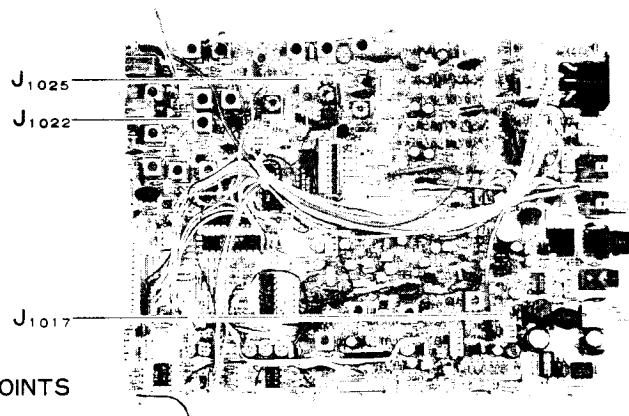

MAIN UNIT ALIGNMENT POINTS

ALIGNMENT

Adjust. Frequency	Adjust. Transformer	Check Freq.	Check Voltage
2.5000	T2006	2.4999	4.5-6.0V
		7.4999	5.0-6.5V
		0.1000	1.5-3.0V
7.5000	T2007	14.4999	5.0-6.5V
14.5000	T2008	21.4999	5.0-6.5V
21.5000	T2009	29.9999	5.0-6.5V

3. Connect the RF voltmeter to pin 13 of Q2024 and tune the transceiver to 29.9999 MHz. Confirm at least 90mVrms on the RF voltmeter.
4. Disconnect the voltmeters.

E. Reference Oscillator

1. Connect the frequency counter to the exposed lead of C2030 (TP2002).
2. Tune the transceiver to 7.0000 MHz, LSB mode.
3. If the TCXO option is installed, adjust the trimmer accessible through the hole in the TCXO housing, if necessary, for 5.7635 MHz \pm 3 Hz on the counter.
4. If the TCXO option is not installed, adjust TC2004, if necessary, for 5.7635 MHz \pm 10 Hz on the counter.
5. Remove the counter.

F. Carrier Point

1. Disconnect TMP plug P2001 from J1017 on the Main Unit, and connect the frequency counter to P2001.
2. With the LSB mode selected, adjust TC2003 for 8.2135 MHz \pm 10 Hz on the counter.
3. Select USB mode and adjust TC2002 for 8.2165 MHz \pm 10 Hz on the counter.
4. Select CW mode and set the DRIVE control fully counterclockwise (minimum).
5. Press the MOX button to transmit, and adjust TC2001 for 8.2158 MHz \pm 10 Hz on the counter.
6. Press the MOX button again to return to receive, remove the counter and reconnect P2001 to J1017 (unless performing the next procedure).

G. Carrier Level

1. Disconnect TMP plug P2003 from J1025 on the Main Unit, and connect a 50-ohm resistor in parallel with the RF voltmeter to P2003.
2. Confirm at least 230 mVrms on the RF voltmeter in all modes.
3. Remove the voltmeter and resistor, and reconnect P2003 to J1025.

II. Main Unit - Receiver

A. RX IF, Part I

1. Connect the RF generator to the antenna jack, and the AF voltmeter and an 8-ohm, 3W resistor across the EXT SPKR jack.
2. Tune the transceiver to 14.2000 MHz, USB mode. Set the AF gain to the 10 o'clock position.
3. Tune the RF generator for a 1.5 kHz heterodyne in the receiver, and adjust the injection level for S-7 on the S-meter.
4. Adjust T1003-T1013 for peak on the AF voltmeter, reducing the injection level, if necessary, to keep S-meter deflection near S-7.
5. Leave the test equipment connected for the next three procedures.

B. S-meter Sensitivity, Part I

1. Connect the RF voltmeter to the emitter of Q1008.
2. Tune the transceiver to 14.0000 MHz, USB mode, and adjust VR1004 for minimum on the voltmeter.
3. Adjust VR1002 so that the S-meter just begins to deflect.
4. Disconnect the voltmeter, and continue with the next procedure.

For Service Manuals Contact
MAURITRON TECHNICAL SERVICES
 8 Cherry Tree Rd, Chinnor
 Oxon OX9 4QY
 Tel: 01844-351694 Fax: 01844-352554
 Email: enquiries@mauritron.co.uk

C. RX IF, Part II

1. Set the transceiver to 14.2000 MHz (USB).
2. Tune the RF generator for a 1.5 kHz heterodyne in the receiver, and adjust the injection level for S-7 on the S-meter.
3. Adjust T1003-T1013 for maximum on the S-meter, reducing the injection level, if necessary, to keep S-meter deflection near S-7.
4. Reduce the injection level to +6dBu and adjust VR1001 for S-1 indication.
5. Perform the next procedure.

1. Set the RF injection level to +100 dBu and adjust VR1003 for S-meter deflection of 60 dB over S-9.
2. Disconnect the test equipment.

E. RX 1st Mixer

1. In LSB mode, tune to the internal heterodyne near 7.1 MHz.
2. Adjust VR1014 for best null of the heterodyne.

F. Noise Squelch

1. Tune to 14.2000 MHz, USB mode, and set the SQL control to the 10 o'clock position.
2. Adjust VR1005 so the squelch just closes when no signal is received.

D. S-Meter Sensitivity, Part II

Perform the preceding procedure, if not done already.

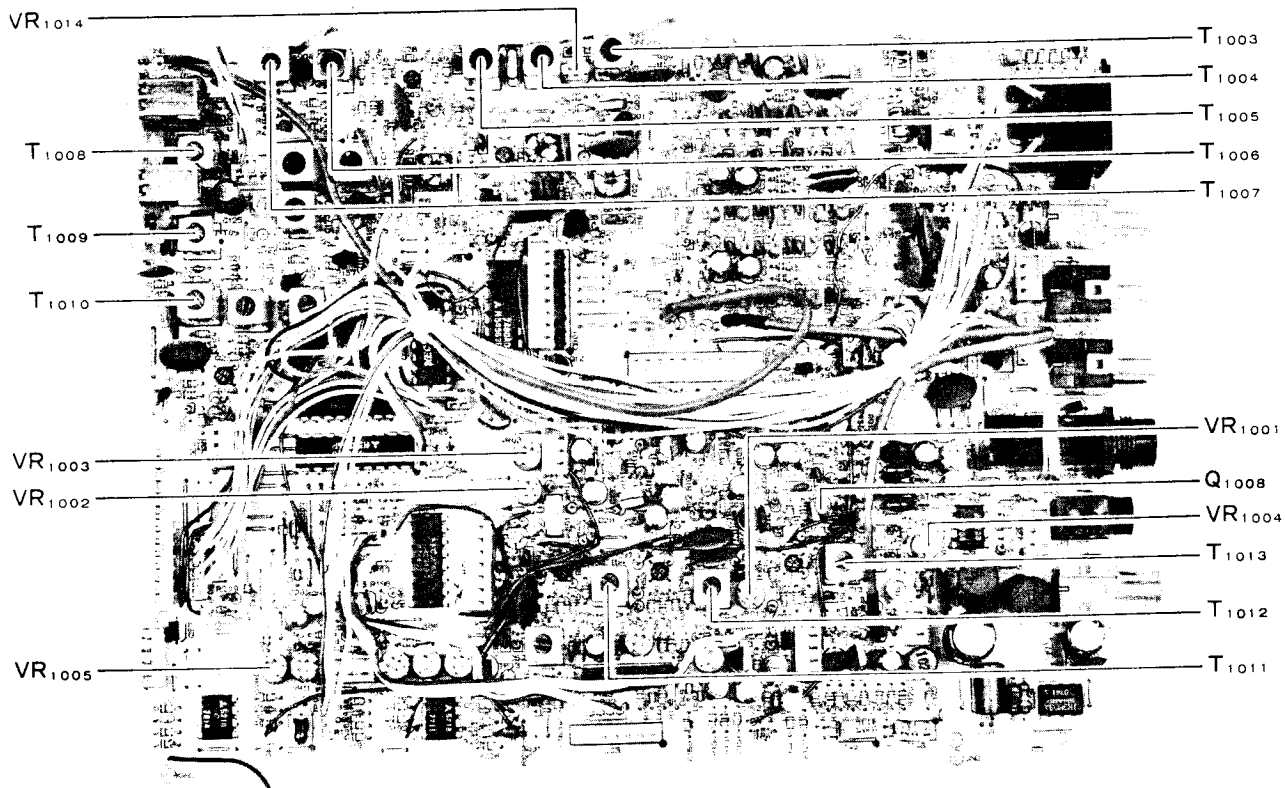

MAIN UNIT ALIGNMENT POINTS
(Receiver Section)

ALIGNMENT

III. Main Unit, Transmitter

A. TX IF

1. Connect the dummy load and wattmeter to the antenna jack, and tune to 14.2000 MHz, CW mode.
2. Press the MOX button and set the DRIVE control for 50W output.
3. Adjust T1014-T1019 for peak on the wattmeter, reducing the DRIVE, if necessary, to keep power below 60W output.
4. Press the MOX button again to return to receive.

B. ALC & PO Meter Sensitivity

1. With the dummy load and wattmeter connected to the antenna jack, and tuned to 14.2000 MHz, CW mode, set the DRIVE control fully clockwise.
2. Press the MOX button and adjust VR1010 for 100W output, and then VR1012 for S-meter deflection to "8" on the PO scale, repeating both adjustments alternately several times.

C. SSB Carrier Balance

1. With the dummy load and wattmeter connected to the antenna jack, and tuned to 14.2000 MHz, USB mode, set the MIC gain fully counterclockwise.
2. Connect the RF voltmeter to J1002.
3. Press the MOX button and adjust VR1007 for minimum on the voltmeter.
4. Press the MOX button again to return to receive, and disconnect the voltmeter.

D. AM Carrier Level

1. With the dummy load and wattmeter connected to the antenna jack, and tuned to 14.2000 MHz, AM mode, set the MIC gain fully counterclockwise.
2. Preset VR1006 fully clockwise.
3. Press the MOX button and set the DRIVE control for 80W output.
4. Adjust VR1006 for 20W output.
5. Press the MOX button again to return to receive, and remove the test equipment.

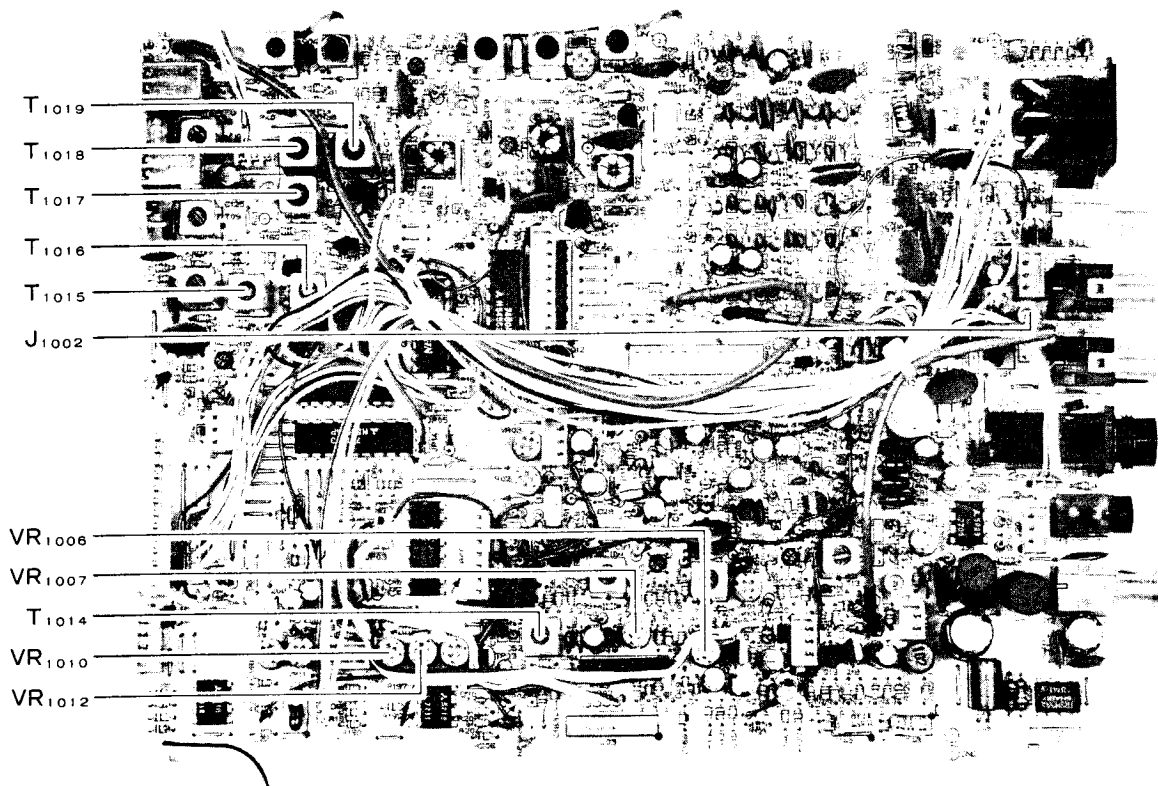

MAIN UNIT ALIGNMENT POINTS
(Transmitter Section)

IV. Noise Blanker Unit

1. Connect the RF generator to the antenna jack, and the DC voltmeter between TP8101 and chassis ground.
2. Tune the transceiver and RF generator to 14.2000 MHz, and inject 40 dBu with no modulation.
3. Press the NB switch and select the USB mode.
4. Adjust T8101 and T8102 for minimum deflection on the voltmeter.
5. Disconnect the test equipment.

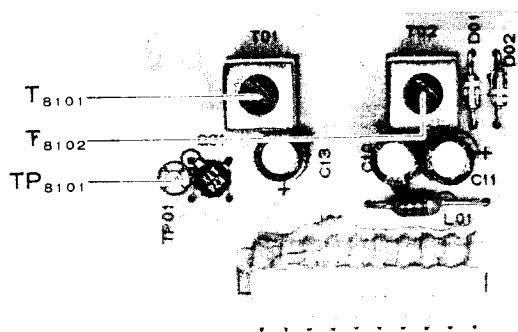

NB UNIT ALIGNMENT POINTS

V. 100W PA Unit (Idling Current)

1. Temporarily remove the jumper indicated below, and connect the DC milliammeter (set to 500 mA range) in its place.
2. Set the transceiver to USB mode, and set the MIC gain fully counterclockwise.
3. Press the MOX button and adjust VR5001 for 200 \pm 50 mA on the milliammeter.
4. Press the MOX button again to return to receive, remove the milliammeter and reinstall the jumper.

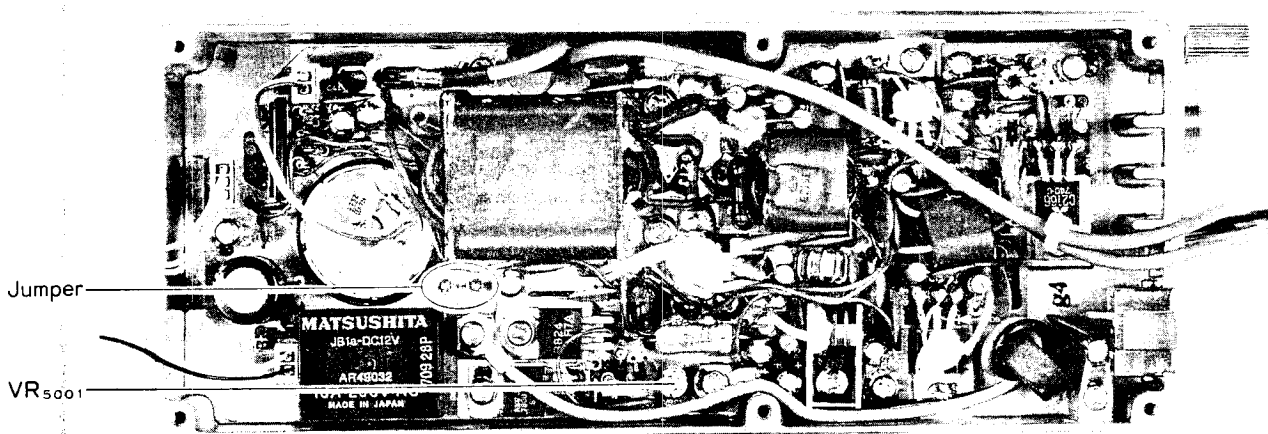
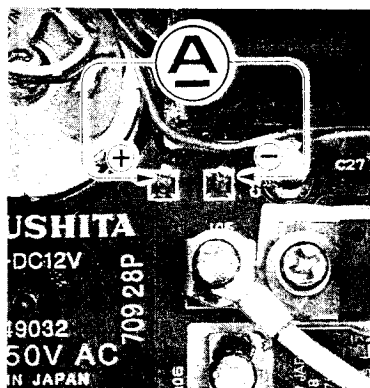

100W PA UNIT ALIGNMENT POINTS

ALIGNMENT

VI. LPF Unit (CM Coupler Balance)

1. Connect the dummy load to the antenna jack, and the DC voltmeter between pin 3 of JP4001 and chassis ground.
2. Tune to 14.2000 MHz, CW mode, and set the DRIVE control fully clockwise.
3. Press the MOX button and adjust TC4001 for minimum deflection on the voltmeter.
4. Press the MOX button again to return to receive, and remove the test equipment.

VII. Main Unit (AFP - Automatic Final Protection)

1. Connect the wattmeter and 16.7-ohm dummy load (three 50-ohm loads in parallel) to the antenna jack.
2. With the transceiver tuned to 14.2000 MHz, CW mode, set the DRIVE control fully clockwise.
3. Press the MOX button and adjust VR1011 for 75W output.
4. Press the MOX button again to return to receive, and disconnect the test equipment.

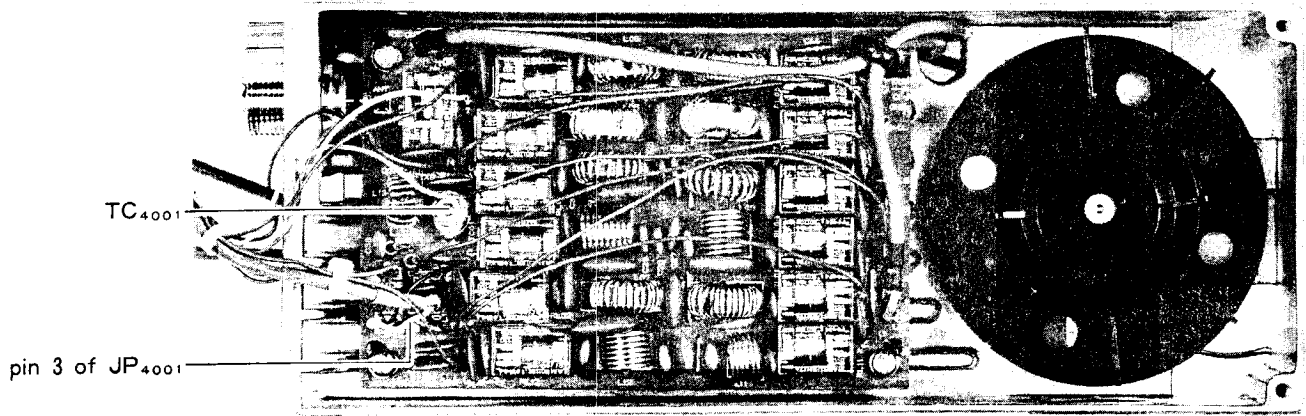

LPF UNIT ALIGNMENT POINTS

For Service Manuals Contact
MAURITRON TECHNICAL SERVICES
8 Cherry Tree Rd, Chinnor
Oxon OX9 4QY
Tel:- 01844-351694 Fax:- 01844-352554
Email:- enquiries@mauritron.co.uk

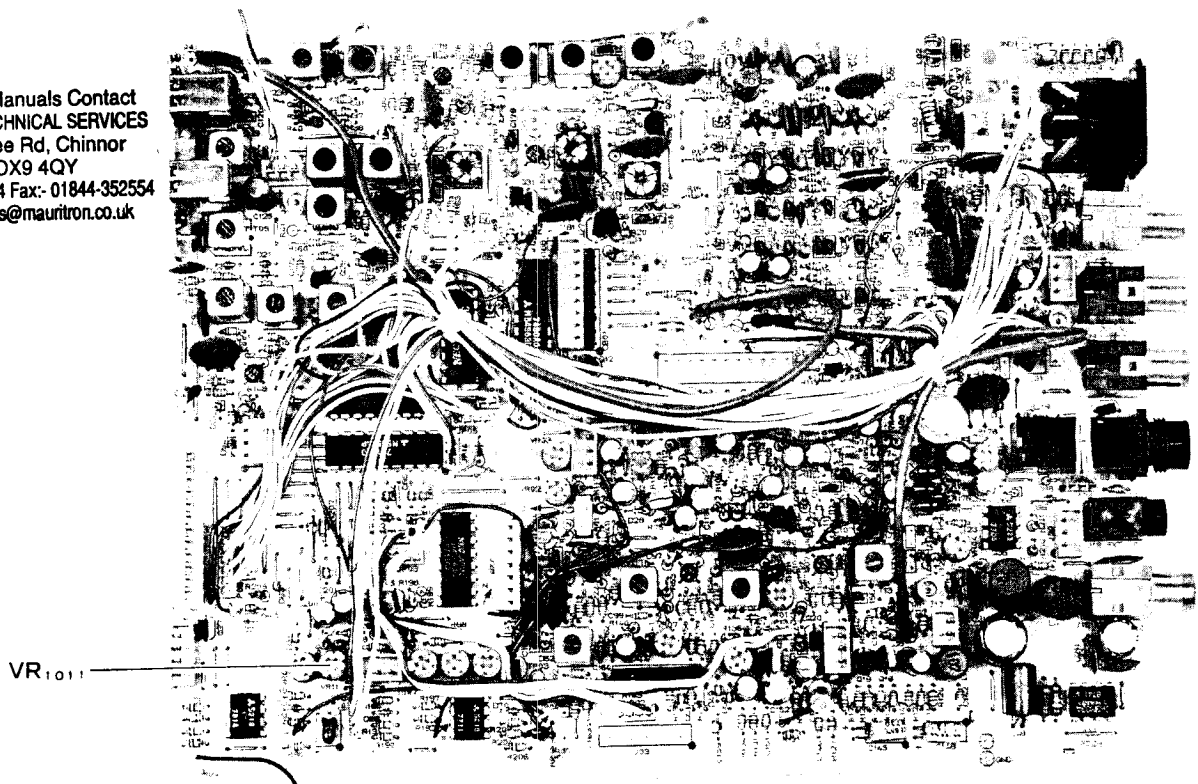

MAIN UNIT ALIGNMENT POINT
(AFP Section)

PARTS LIST

R3123850A R3123870A R3123891 R3124020A R3124030B R3124040B R3124050A R3512400A R3128400 R0805150A R0805160A R5512410 R0510960 R0510970A R4804670B R0125890 R0124060 R0126000 R7125830 R7125230 R7125850 R3124800 R7049015 R3100700 R0100690A R7125160 R7125170 R7125430 R7125450 R7125460 R7125630 R7125631 R7125900 R7129010 R0116420 R3126040 S4000041 R6100980A R7126400 R7126410 R7126640	Button (CLAR) Button (D LOCK) Button (MODE) Button (POWER) Button (NAR) Button (ATT) Button (NB,MOX) Switch Cover Switch Cover Top Cover Bottom Cover Side Sash Heatsink Cover Heatsink Cover Heatsink Cover Speaker Clamp Speaker Clamp Clamp Mylar Sheet Fiber Insulator Fiber Insulator Diffusor Speaker Net Foot Wire Stand Sponge 8x9x4 Sponge 8x8x6 Sponge 15x6x4 Sponge 10x6x4 Sponge 8x6x8 Sponge 7x7x50 w/Double Sided Adhesive Tape Sponge 7x7x50 w/o Double Sided Adhesive Tape Sponge 24x10x4 Rubber 10x10x10.5 Ground Lug Terminal Rubber Foot Rubber Foot (RK-16) Nut for Phone Jack Phenol Fiber Sheet
---	---

MAIN CHASSIS			
Q01 Q02	IC IC Thermal Gasket Insulator	L7809 uPC7808H 30F-TO-220 AC316A	AF/SQ MIC/DRIVE
VR01 VR02	Potentiometer Potentiometer	10KA/10KB 10KB/10KB	25V Sr 50V F 50V B 50V F 50V Sr
C01 C02 C03 C04 C05	Ceramic Cap. Ceramic Cap. Ceramic Cap. Ceramic Cap. Ceramic Cap.	0.1uF 0.047uF 0.001uF 0.01uF 0.1uF	
L01 L02	Toroidal Core Toroidal Core	3A R1 9.3X4.8-5 KQ-1 15-8-7	
M01	Meter	MG-20L	
MO01	Fan Motor Fan Motor Bracket Fan Blades	MDN-7R1	
SP01	Loudspeaker	SS-57	
J01 J02 J03	Antenna Socket Mic Socket PS(13.5VDC) Socket	FM-MR-M2 FM-214-8SS(A) QS-1B4M	
TB01	Grounding Post	BP-19	
P01 P03 P05 P07 P08 P09 P10 P11 P12 P13 P14 P15	Wire Assy w/P02 Wire Assy w/P04 Wire Assy w/P06 Wire Assy Wire Assy Wire Assy Wire Assy Wire Assy Wire Assy Wire Assy Wire Assy Wire Assy		
R3510941	Front Panel		
R3123790	Display Filter		
R3123800A R3124190 R3123830 R3123840	Knob (Tuning) Rubber Knurl Knobs (AF,MIC) Knobs (SQL,DRIVE)		

For Service Manuals Contact
MAURITRON TECHNICAL SERVICES
 8 Cherry Tree Rd, Chinnor
 Oxon OX9 4QY
 Tel: 01844-351694 Fax: 01844-352554
 Email: enquiries@mauritron.co.uk

PARTS LIST

MAIN UNIT		PCB with components w/ NB UNIT		PCB with components w/o NB UNIT		Printed Circuit Board	
CPI252003							
CPI253003							
F2942000B							
Q1001	G3801250	FET	2SK125	D1005	G2090340	Diode	1SS83
Q1002	G3801250	FET	2SK125	D1006	G2090340	Diode	1SS83
Q1003	G4800740L	FET	3SK74L	D1007	G2090340	Diode	1SS83
Q1004	G3802410Y	FET	2SK241Y	D1008	G2090340	Diode	1SS83
Q1005	G4800740L	FET	3SK74L	D1009	G2090340	Diode	1SS83
Q1006	G4800740L	FET	3SK74L	D1010	G2090340	Diode	1SS83
Q1007	G4800740L	FET	3SK74L	D1011	G2090340	Diode	1SS83
Q1008	G3304580B	Transistor	2SC458B	D1012	G2090340	Diode	1SS270TJ
Q1009	G3304580B	Transistor	2SC458B	D1013	G2090340	Diode	1SS270TJ
Q1010	G3801040J	FET	2SK104J	D1014	G2090340	Diode	1SS270TJ
Q1011	G3801921G	FET	2SK192AGR	D1015	G2090340	Diode	1SS270TJ
Q1012	G3107331P	Transistor	2SA733AP	D1016	G2090340	Diode	1SS270
Q1013	G3090074	Transistor	BA1A4M	D1017	G2090340	Diode	1SS106
Q1014	G1090633	IC	M5218P	D1018	G2090340	Diode	1SS106
Q1015	G3304580B	Transistor	2SC458B	D1019	G2060004	Diode	1SS270TJ
Q1016	G3304580B	Transistor	2SC458B	D1021	G2060004	Diode	1SS270TJ
Q1017	G3090077	Transistor	BA1L3Z	D1022	G2060004	Diode	1SS270TJ
Q1018	G3304580B	Transistor	2SA458B	D1023	G2060004	Diode	1SS270TJ
Q1019	G3304580B	Transistor	2SA458B	D1024	G2090408	Diode	1SS270
Q1020	G3090074	Transistor	BA1A4M	D1025	G2090244	Diode	1SS106
Q1021	G3304580B	Transistor	2SC458B	D1026	G2090244	Diode	1SS106
Q1022	G1090101	IC	uPC1037H	D1027	G2090244	Diode	1SS106
Q1023	G4800740L	FET	3SK74L	D1028	G2060004	Diode	1SS270TJ
Q1024	G3802410Y	FET	2SK241Y	D1029	G2060004	Diode	1SS270TJ
Q1025	G3802410Y	FET	2SK241Y	D1030	G2060004	Diode	1SS270TJ
Q1026	G3305350B	Transistor	2SC535B	D1031	G2060004	Diode	1SS270TJ
Q1027	G3801250	FET	2SK125	D1032	G2060004	Diode	1SS270TJ
Q1028	G3304580B	Transistor	2SC458B	D1033	G2060004	Diode	1SS270TJ
Q1029	G3090074	Transistor	BA1A4M	D1034	G2060004	Diode	1SS106
Q1030	G3090074	Transistor	BA1A4M	D1035	G2090244	Diode	1SS106
Q1031	G3090078	Transistor	DTA143ES	D1036	G2090244	Diode	1SS106
Q1032	G3320530	Transistor	2SC2053	D1037	G2090244	Diode	1SS106
Q1033	G3090074	Transistor	BA1A4M	D1038	G2090244	Diode	1SS270
Q1034	G1090633	IC	M5218P	D1039	G2090408	Diode	1SS270
Q1035	G3304584B	Transistor	2SC458BTZ	D1040	G2090408	Diode	1SS270
Q1036	G1090749	IC	M5223P	D1041	G2090408	Diode	1SS270TJ
Q1037	G3090074	Transistor	BA1A4M	D1042	G2060004	Diode	1SS270
Q1038	G1090721	IC	M54563P	D1044	G2090408	Diode	1SS270
Q1039	G1090657	IC	uPD4028BC	D1045	G2060004	Diode	1SS270TJ
Q1040	G1090836	IC	M54564P	D1046	G2060004	Diode	1SS270TJ
Q1041	G1090297	IC	uPD4094BC	D1047	G2060004	Diode	1SS270TJ
Q1042	G1090297	IC	uPD4094BC	D1048	G2060004	Diode	1SS270TJ
Q1043	G3090078	Transistor	DTA143ES	D1049	G2060004	Diode	1SS270TJ
Q1044	G3406691	Transistor	2SD669A	D1050	G2060004	Diode	1SS270
Q1045	G1090837	IC	IR3M03A	D1051	G2060004	Diode	1SS270
Q1046	G3090074	Transistor	BA1A4M	D1052	G2090408	Diode	1SS270
Q1047	G3304580B	Transistor	2SC458B	D1053	G2090408	Diode	1SS270
Q1048	G3090077	Transistor	BA1L3Z	D1054	G2090408	Diode	1SS270
Q1049	G3304580B	Transistor	2SC458B	D1055	G2090135	Diode	ND487C2-3R
D1001	G2090340	Diode	1SS83	D1056	G2090340	Diode	1SS83
D1002	G2090340	Diode	1SS83	D1057	G5090340	Diode	1SS83
D1003	G2090340	Diode	1SS83	D1058	G9090007	Diode	MV12
D1004	G2090340	Diode	1SS83	D1059	G2090229	Diode	1SS83
				D1060	G2090229	Diode	HZ7B1
				D1061	G2060004	Diode	HZ7B1
				D1062	G2060004	Diode	1SS270TJ
				D1063	G2060004	Diode	1SS270TJ
				D1064	G2090408	Diode	1SS270
				D1065	G2060004	Diode	1SS270TJ
				D1066	G2090408	Diode	1SS270
				D1067	G2090118	Diode	1SS97
				D1068	G2060004	Diode	1SS270TJ

PARTS LIST

R1031	J01225683	Carbon Film Res.	68k ohm	1/6W	PJ
R1032	J01225104	Carbon Film Res.	100k ohm	1/6W	PJ
R1033	J01225684	Carbon Film Res.	68k ohm	1/6W	PJ
R1034	J01225272	Carbon Film Res.	2.7k ohm	1/6W	PJ
R1035	J01225153	Carbon Film Res.	15k ohm	1/6W	PJ
R1036	J01225101	Carbon Film Res.	100 ohm	1/6W	PJ
R1037	J01225471	Carbon Film Res.	470 ohm	1/6W	PJ
R1038	J01225560	Carbon Film Res.	56 ohm	1/6W	PJ
R1039	J01225101	Carbon Film Res.	100 ohm	1/6W	PJ
R1042	J01225682	Carbon Film Res.	6.8k ohm	1/6W	PJ
R1043	J01225472	Carbon Film Res.	4.7k ohm	1/6W	PJ
R1044	J01225331	Carbon Film Res.	330 ohm	1/6W	PJ
R1045	J02225331	Carbon Film Res.	330 ohm	1/6W	PJ
R1046	J02225104	Carbon Film Res.	100k ohm	1/6W	PJ
R1047	J02225681	Carbon Film Res.	680 ohm	1/6W	PJ
R1048	J02225184	Carbon Film Res.	180k ohm	1/6W	PJ
R1049	J01225471	Carbon Film Res.	470 ohm	1/6W	PJ
R1050	J01225151	Carbon Film Res.	150 ohm	1/6W	PJ
R1051	J02225101	Carbon Film Res.	100 ohm	1/6W	PJ
R1052	J01225153	Carbon Film Res.	15k ohm	1/6W	PJ
R1053	J02225273	Carbon Film Res.	27k ohm	1/6W	PJ
R1054	J02225103	Carbon Film Res.	10k ohm	1/6W	PJ
R1055	J02225471	Carbon Film Res.	470 ohm	1/6W	PJ
R1056	J01225151	Carbon Film Res.	150 ohm	1/6W	PJ
R1057	J02225101	Carbon Film Res.	100 ohm	1/6W	PJ
R1058	J01225153	Carbon Film Res.	15k ohm	1/6W	PJ
R1060	J01225393	Carbon Film Res.	39k ohm	1/6W	PJ
R1061	J01225103	Carbon Film Res.	10k ohm	1/6W	PJ
R1062	J01225221	Carbon Film Res.	220 ohm	1/6W	PJ
R1063	J01225221	Carbon Film Res.	220 ohm	1/6W	PJ
R1064	J02225101	Carbon Film Res.	100 ohm	1/6W	PJ
R1065	J01225153	Carbon Film Res.	15k ohm	1/6W	PJ
R1066	J01225333	Carbon Film Res.	33k ohm	1/6W	PJ
R1067	J01225683	Carbon Film Res.	68k ohm	1/6W	PJ
R1068	J02225222	Carbon Film Res.	2.2k ohm	1/6W	PJ
R1069	J02225102	Carbon Film Res.	1k ohm	1/6W	PJ
R1070	J02225104	Carbon Film Res.	100k ohm	1/6W	PJ
R1071	J01225101	Carbon Film Res.	100 ohm	1/6W	PJ
R1072	J02225682	Carbon Film Res.	6.8k ohm	1/6W	PJ
R1073	J02225472	Carbon Film Res.	4.7k ohm	1/6W	PJ
R1074	J02225155	Carbon Film Res.	1.5M ohm	1/6W	PJ
R1075	J02225103	Carbon Film Res.	10k ohm	1/6W	PJ
R1076	J02225103	Carbon Film Res.	10k ohm	1/6W	PJ
R1077	J02225103	Carbon Film Res.	47k ohm	1/6W	PJ
R1078	J02225473	Carbon Film Res.	100k ohm	1/6W	PJ
R1079	J02225104	Carbon Film Res.	1k ohm	1/6W	PJ
R1080	J02225102	Carbon Film Res.	1.5k ohm	1/6W	PJ
R1082	J02225152	Carbon Film Res.	10k ohm	1/6W	PJ
R1083	J01225103	Carbon Film Res.	10k ohm	1/6W	PJ
R1084	J01225682	Carbon Film Res.	6.8k ohm	1/6W	PJ
R1087	J01225392	Carbon Film Res.	3.9k ohm	1/6W	PJ
R1088	J01225564	Carbon Film Res.	560k ohm	1/6W	PJ
R1089	J01225104	Carbon Film Res.	100k ohm	1/6W	PJ
R1090	J01225472	Carbon Film Res.	4.7k ohm	1/6W	PJ
R1091	J01225104	Carbon Film Res.	100k ohm	1/6W	PJ
R1092	J01225225	Carbon Film Res.	2.2M ohm	1/6W	PJ
R1094	J01225103	Carbon Film Res.	10k ohm	1/6W	PJ
R1095	J01225222	Carbon Film Res.	2.2k ohm	1/6W	PJ
R1096	J01225472	Carbon Film Res.	4.7k ohm	1/6W	PJ
R1097	J02225223	Carbon Film Res.	22k ohm	1/6W	PJ
R1098	J01225471	Carbon Film Res.	470 ohm	1/6W	PJ
R1099	J02225472	Carbon Film Res.	4.7k ohm	1/6W	PJ

For Service Manuals Contact
MAURITRON TECHNICAL SERVICES
 8 Cherry Tree Rd, Chinnor
 Oxon OX9 4QY
 Tel: 01844-351694 Fax: 01844-352554
 Email: enquiries@mauritron.co.uk

D1069	G2090408	Diode	1SS270	1/6W	PJ
D1070	G2060004	Diode	1SS270TJ	1/6W	PJ
D1071	G2060004	Diode	1SS270TJ	1/6W	PJ
D1072	G2090408	Diode	1SS270	1/6W	PJ
D1073	G2090408	Diode	1SS270	1/6W	PJ
D1074	G2090408	Diode	1SS270	1/6W	PJ
D1077	G2090408	Diode	1SS270	1/6W	PJ
D1078	G2090408	Diode	1SS270	1/6W	PJ
D1079	G2090408	Diode	1SS270TJ	1/6W	PJ
D1080	G2060004	Diode	1SS270TJ	1/6W	PJ
D1081	G2090408	Diode	1SS270TJ	1/6W	PJ
D1082	G2060004	Diode	1SS270TJ	1/6W	PJ
D1083	G2060004	Diode	1SS270TJ	1/6W	PJ
D1084	G2060004	Diode	1SS270TJ	1/6W	PJ
D1085	G2060004	Diode	1SS270TJ	1/6W	PJ
D1086	G2090002	Diode	10D10	1/6W	PJ
D1087	G2060004	Diode	1SS270	1/6W	PJ
D1088	G2090408	Diode	1SS270	1/6W	PJ
D1089	G2090408	Diode	1SS83	1/6W	PJ
D1090	G2090340	Diode	1SS270	1/6W	PJ
D1091	G2090408	Diode	1SS270TJ	1/6W	PJ
D1093	G2060004	Diode	1SS270	1/6W	PJ
D1094	G2090408	Diode	1SS270TJ	1/6W	PJ
D1097	G2060004	Diode	1SS270TJ	1/6W	PJ
D1098	G2060004	Diode	1SS270TJ	1/6W	PJ
D1099	G2090226	Diode	HZ4C3	1/6W	PJ
D1100	G2090408	Diode	1SS270	1/6W	PJ
D1101	G2090408	Diode	1SS270	1/6W	PJ
TH1001	G9090010	Thermistor	112302-2	1/6W	PJ
TH1002	G9090008	Thermistor	112102-2	1/6W	PJ
TH1003	G9090015	Thermistor	SDT-100	1/6W	PJ
TH1004	G9090039	Thermistor	112152-2	1/6W	PJ
XF1001	H1102090	Crystal Filter	47M15AU	1/6W	PJ
R1001	J01225471	Carbon Film Res.	470 ohm	1/6W	PJ
R1002	J02225560	Carbon Film Res.	56 ohm	1/6W	PJ
R1003	J02225102	Carbon Film Res.	1k ohm	1/6W	PJ
R1004	J01225102	Carbon Film Res.	1k ohm	1/6W	PJ
R1005	J01225102	Carbon Film Res.	1k ohm	1/6W	PJ
R1006	J01225471	Carbon Film Res.	470 ohm	1/6W	PJ
R1007	J02245471	Carbon Film Res.	470 ohm	1/6W	PJ
R1008	J02245101	Carbon Film Res.	100 ohm	1/6W	PJ
R1009	J01225101	Carbon Film Res.	100 ohm	1/6W	PJ
R1010	J01225101	Carbon Film Res.	100 ohm	1/6W	PJ
R1011	J01225101	Carbon Film Res.	100 ohm	1/6W	PJ
R1012	J01225101	Carbon Film Res.	100 ohm	1/6W	PJ
R1013	J01225101	Carbon Film Res.	100 ohm	1/6W	PJ
R1014	J01225101	Carbon Film Res.	100 ohm	1/6W	PJ
R1015	J01225101	Carbon Film Res.	100 ohm	1/6W	PJ
R1016	J01225101	Carbon Film Res.	100 ohm	1/6W	PJ
R1017	J01225101	Carbon Film Res.	100 ohm	1/6W	PJ
R1018	J01225101	Carbon Film Res.	100 ohm	1/6W	PJ
R1019	J01225121	Carbon Film Res.	390 ohm	1/6W	PJ
R1020	J01225391	Carbon Film Res.	100k ohm	1/6W	PJ
R1022	J01225104	Carbon Film Res.	100k ohm	1/6W	PJ
R1023	J02225104	Carbon Film Res.	470 ohm	1/6W	PJ
R1024	J01225471	Carbon Film Res.	470 ohm	1/6W	PJ
R1025	J01225471	Carbon Film Res.	470 ohm	1/6W	PJ
R1027	J01225101	Carbon Film Res.	100 ohm	1/6W	PJ
R1030	J01225393	Carbon Film Res.	39k ohm	1/6W	PJ

PARTS LIST

R1100	J01225102	Carbon Film Res.	1k ohm	1/6W	PJ
R1101	J01225103	Carbon Film Res.	10k ohm	1/6W	PJ
R1102	J01225682	Carbon Film Res.	6.8k ohm	1/6W	PJ
R1103	J01225682	Carbon Film Res.	6.8k ohm	1/6W	PJ
R1104	J02225682	Carbon Film Res.	6.8k ohm	1/6W	PJ
R1105	J01225154	Carbon Film Res.	150k ohm	1/6W	PJ
R1106	J01225101	Carbon Film Res.	100 ohm	1/6W	PJ
R1107	J01225102	Carbon Film Res.	1k ohm	1/6W	PJ
R1108	J02225103	Carbon Film Res.	10k ohm	1/6W	PJ
R1109	J01225223	Carbon Film Res.	22k ohm	1/6W	PJ
R1110	J02225683	Carbon Film Res.	68k ohm	1/6W	PJ
R1111	J01225101	Carbon Film Res.	100 ohm	1/6W	PJ
R1112	J02225220	Carbon Film Res.	3.3k ohm	1/6W	PJ
R1113	J02225222	Carbon Film Res.	22 ohm	1/6W	PJ
R1114	J02225102	Carbon Film Res.	1k ohm	1/6W	PJ
R1115	J02225101	Carbon Film Res.	100 ohm	1/6W	PJ
R1116	J01225332	Carbon Film Res.	3.3k ohm	1/6W	PJ
R1117	J02225472	Carbon Film Res.	4.7k ohm	1/6W	PJ
R1119	J01225103	Carbon Film Res.	10k ohm	1/6W	PJ
R1120	J01225102	Carbon Film Res.	1k ohm	1/6W	PJ
R1121	J01225101	Carbon Film Res.	100 ohm	1/6W	PJ
R1122	J01225223	Carbon Film Res.	22k ohm	1/6W	PJ
R1123	J01225331	Carbon Film Res.	330 ohm	1/6W	PJ
R1124	J01225153	Carbon Film Res.	15k ohm	1/6W	PJ
R1125	J01225222	Carbon Film Res.	2.2k ohm	1/6W	PJ
R1126	J01225151	Carbon Film Res.	150 ohm	1/6W	PJ
R1127	J01225221	Carbon Film Res.	220 ohm	1/6W	PJ
R1130	J02225222	Carbon Film Res.	2.2k ohm	1/6W	PJ
R1131	J01225101	Carbon Film Res.	100 ohm	1/6W	PJ
R1132	J01225473	Carbon Film Res.	47k ohm	1/6W	PJ
R1133	J01225473	Carbon Film Res.	47k ohm	1/6W	PJ
R1134	J01225681	Carbon Film Res.	680 ohm	1/6W	PJ
R1135	J01225221	Carbon Film Res.	220 ohm	1/6W	PJ
R1136	J02225102	Carbon Film Res.	1k ohm	1/6W	PJ
R1137	J01225102	Carbon Film Res.	1k ohm	1/6W	PJ
R1138	J01225153	Carbon Film Res.	15k ohm	1/6W	PJ
R1139	J01225104	Carbon Film Res.	100k ohm	1/6W	PJ
R1140	J02225222	Carbon Film Res.	2.2k ohm	1/6W	PJ
R1141	J01225102	Carbon Film Res.	1k ohm	1/6W	PJ
R1142	J01225101	Carbon Film Res.	100 ohm	1/6W	PJ
R1143	J01225102	Carbon Film Res.	1k ohm	1/6W	PJ
R1144	J01225223	Carbon Film Res.	22k ohm	1/6W	PJ
R1145	J01225102	Carbon Film Res.	1k ohm	1/6W	PJ
R1146	J01225221	Carbon Film Res.	330 ohm	1/6W	PJ
R1147	J01225331	Carbon Film Res.	2.7k ohm	1/6W	PJ
R1148	J02225272	Carbon Film Res.	680 ohm	1/6W	PJ
R1149	J01225681	Carbon Film Res.	100 ohm	1/6W	PJ
R1150	J01225101	Carbon Film Res.	220 ohm	1/6W	PJ
R1151	J02225221	Carbon Film Res.	220 ohm	1/6W	PJ
R1152	J02225472	Carbon Film Res.	4.7k ohm	1/6W	PJ
R1153	J01225101	Carbon Film Res.	100 ohm	1/6W	PJ
R1155	J02225332	Carbon Film Res.	3.3k ohm	1/6W	PJ
R1157	J01225224	Carbon Film Res.	220k ohm	1/6W	PJ
R1158	J01225471	Carbon Film Res.	470 ohm	1/6W	PJ
R1159	J01225471	Carbon Film Res.	470 ohm	1/6W	PJ
R1160	J01225101	Carbon Film Res.	100 ohm	1/6W	PJ
R1161	J01225101	Carbon Film Res.	100 ohm	1/6W	PJ
R1162	J01225223	Carbon Film Res.	22k ohm	1/6W	PJ
R1163	J02225221	Carbon Film Res.	220 ohm	1/6W	PJ
R1167	J01225470	Carbon Film Res.	47 ohm	1/6W	PJ
R1168	J01225103	Carbon Film Res.	10k ohm	1/6W	PJ
R1169	J01225680	Carbon Film Res.	68 ohm	1/6W	PJ
R1170	J01225102	Carbon Film Res.	1k ohm	1/6W	PJ
R1172	J01225101	Carbon Film Res.	100 ohm	1/6W	PJ
R1173	J02225333	Carbon Film Res.	33k ohm	1/6W	PJ
R1174	J02225472	Carbon Film Res.	4.7k ohm	1/6W	PJ
R1175	J02225472	Carbon Film Res.	4.7k ohm	1/6W	PJ
R1176	J02225472	Carbon Film Res.	4.7k ohm	1/6W	PJ
R1177	J02225472	Carbon Film Res.	4.7k ohm	1/6W	PJ
R1178	J01225331	Carbon Film Res.	330 ohm	1/6W	PJ
R1179	J02225224	Carbon Film Res.	220k ohm	1/6W	PJ
R1180	J01225101	Carbon Film Res.	100 ohm	1/6W	PJ
R1181	J02225101	Carbon Film Res.	100 ohm	1/6W	PJ
R1182	J01225102	Carbon Film Res.	1k ohm	1/6W	PJ
R1183	J01225681	Carbon Film Res.	680 ohm	1/6W	PJ
R1184	J01225152	Carbon Film Res.	1.5k ohm	1/6W	PJ
R1185	J02225479	Carbon Film Res.	4.7 ohm	1/6W	PJ
R1186	J02225181	Carbon Film Res.	100 ohm	1/6W	PJ
R1187	J01225391	Carbon Film Res.	390 ohm	1/6W	PJ
R1188	J01225102	Carbon Film Res.	1k ohm	1/6W	PJ
R1189	J01225221	Carbon Film Res.	220 ohm	1/6W	PJ
R1190	J01225103	Carbon Film Res.	10k ohm	1/6W	PJ
R1191	J01225104	Carbon Film Res.	100k ohm	1/6W	PJ
R1192	J01225104	Carbon Film Res.	100k ohm	1/6W	PJ
R1193	J02225103	Carbon Film Res.	10k ohm	1/6W	PJ
R1194	J01225823	Carbon Film Res.	82k ohm	1/6W	PJ
R1195	J02225562	Carbon Film Res.	5.6k ohm	1/6W	PJ
R1197	J01225154	Carbon Film Res.	150k ohm	1/6W	PJ
R1198	J02225473	Carbon Film Res.	47k ohm	1/6W	PJ
R1200	J02225103	Carbon Film Res.	10k ohm	1/6W	PJ
R1201	J02225105	Carbon Film Res.	1M ohm	1/6W	PJ
R1202	J02225333	Carbon Film Res.	33k ohm	1/6W	PJ
R1203	J01225223	Carbon Film Res.	22k ohm	1/6W	PJ
R1204	J01225334	Carbon Film Res.	330k ohm	1/6W	PJ
R1206	J01225104	Carbon Film Res.	100k ohm	1/6W	PJ
R1208	J02225472	Carbon Film Res.	4.7k ohm	1/6W	PJ
R1209	J02225562	Carbon Film Res.	5.6k ohm	1/6W	PJ
R1210	J02225153	Carbon Film Res.	15k ohm	1/6W	PJ
R1211	J02225104	Carbon Film Res.	100k ohm	1/6W	PJ
R1212	J01225221	Carbon Film Res.	220 ohm	1/6W	PJ
R1213	J02225103	Carbon Film Res.	10k ohm	1/6W	PJ
R1214	J01225103	Carbon Film Res.	10k ohm	1/6W	PJ
R1216	J02225472	Carbon Film Res.	4.7k ohm	1/6W	PJ
R1217	J01225104	Carbon Film Res.	100k ohm	1/6W	PJ
R1218	J01225823	Carbon Film Res.	82k ohm	1/6W	PJ
R1219	J02225222	Carbon Film Res.	2.2k ohm	1/6W	PJ
R1220	J01225103	Carbon Film Res.	10k ohm	1/6W	PJ
R1221	J02225102	Carbon Film Res.	1k ohm	1/6W	PJ
R1222	J02225221	Carbon Film Res.	220 ohm	1/6W	PJ
R1223	J02225221	Carbon Film Res.	220 ohm	1/6W	PJ
R1224	J02225221	Carbon Film Res.	220 ohm	1/6W	PJ
R1225	J02225221	Carbon Film Res.	220 ohm	1/6W	PJ
R1226	J01225103	Carbon Film Res.	10k ohm	1/6W	PJ
R1227	J01225103	Carbon Film Res.	10k ohm	1/6W	PJ
R1230	J20249046	Carbon Film Res.	8.87k ohm	1/4W	PJ
R1231	J20249102	Carbon Film Res.	1.43k ohm	1/4W	PJ
R1233	J01225101	Carbon Film Res.	100 ohm	1/6W	PJ
R1234	J01225101	Carbon Film Res.	100 ohm	1/6W	PJ
R1235	J02225473	Carbon Film Res.	47k ohm	1/6W	PJ
R1236	J02225103	Carbon Film Res.	10k ohm	1/6W	PJ
R1237	J01225471	Carbon Film Res.	470 ohm	1/6W	PJ
R1238	J02225104	Carbon Film Res.	100k ohm	1/6W	PJ
R1239	J01225473	Carbon Film Res.	47k ohm	1/6W	PJ
R1240	J01225561	Carbon Film Res.	560 ohm	1/6W	PJ

PARTS LIST

Part No.	Description	Value	Code	Notes	Part No.	Description	Value	Code	Notes
R1241	Carbon Film Res.	1/6W	PJ		C1044	K28129001	0.01uF	Y	
R1242	Carbon Film Res.	1/6W	PJ		C1045	K40129004	10uF	SL	
R1243	Carbon Film Res.	1/6W	UJ		C1046	K00175330	33pF	Y	
R1244	Carbon Film Res.	1/6W	PJ		C1047	K28129001	0.01uF	SL	
R1245	Carbon Film Res.	1/6W	UJ		C1048	K00175270	27pF	SL	
R1246	Carbon Film Res.	1/6W	UJ		C1049	K00175121	120pF	SL	
VR1001	POT.	4.7k ohm	B		C1050	K00175270	27pF	SL	
VR1002	POT.	10k ohm	B		C1051	K00175330	33pF	Y	
VR1003	POT.	1M ohm	B		C1052	K28129001	0.01uF	Y	
VR1004	POT.	1k ohm	B		C1053	K40129004	10uF	SL	
VR1005	POT.	470k ohm	B		C1054	K00173080	8pF	Y	
VR1006	POT.	10k ohm	B		C1055	K28129001	0.01uF	SL	
VR1007	POT.	10k ohm	B		C1056	K00175180	18pF	SL	
VR1008	POT.	10k ohm	B		C1057	K00175101	100pF	SL	
VR1009	POT.	10k ohm	B		C1058	K00175180	18pF	SL	
VR1010	POT.	4.7k ohm	B		C1059	K00175150	15pF	Y	
VR1011	POT.	470k ohm	B		C1060	K28129001	0.01uF	Y	
VR1012	POT.	470k ohm	B		C1061	K40129004	10uF	Y	
VR1013	POT.	470k ohm	B		C1062	K28129001	0.01uF	Y	
VR1014	POT.	470 ohm	B		C1063	K28129001	0.047uF	F	
C1001	Ceramic Cap.	0.1uF	25V		C1064	K13179009	10pF	SL	
C1002	Ceramic Cap.	0.047uF	50V		C1065	K00173100	0.047uF	F	
C1003	Ceramic Cap.	0.01uF	16V		C1066	K13179009	0.047uF	F	
C1004	Ceramic Cap.	68pF	50V		C1067	K13179009	0.047uF	Y	
C1005	Ceramic Cap.	82pF	50V		C1070	K28129001	0.01uF	Y	
C1006	Ceramic Cap.	150pF	50V		C1071	K28129001	0.01uF	Y	
C1007	Ceramic Cap.	22pF	50V		C1073	K13179009	0.047uF	F	
C1008	Ceramic Cap.	0.047uF	50V		C1074	K00175470	47uF	SL	
C1009	Ceramic Cap.	62pF	50V		C1075	K00175101	100pF	SL	
C1010	Ceramic Cap.	0.1uF	25V		C1076	K28129001	0.01uF	Y	
C1011	Ceramic Cap.	0.1uF	25V		C1077	K13179009	0.047uF	Y	
C1012	Al Electro Cap.	10uF	16V		C1078	K28129001	0.01uF	Y	
C1013	Ceramic Cap.	0.047uF	25V		C1079	K22170805	1000pF	B	
C1014	Ceramic Cap.	220pF	50V		C1080	K28129001	1000pF	B	
C1015	Ceramic Cap.	510pF	50V		C1081	K28179001	1000pF	B	
C1016	Ceramic Cap.	220pF	50V		C1082	K22170805	100pF	SL	
C1017	Ceramic Cap.	0.01uF	16V		C1083	K28129001	100pF	SL	
C1018	Ceramic Cap.	10uF	16V		C1085	K00175101	10pF	SL	
C1019	Al Electro Cap.	0.047uF	50V		C1087	K00173100	10pF	SL	
C1020	Ceramic Cap.	150pF	50V		C1088	K19149021	0.047uF	Y	
C1021	Ceramic Cap.	0.047uF	50V		C1089	K28129001	0.01uF	Y	
C1022	Ceramic Cap.	180pF	50V		C1090	K19149025	0.1uF	Y	
C1023	Ceramic Cap.	470pF	50V		C1091	K28129001	0.1uF	Y	
C1024	Ceramic Cap.	180pF	50V		C1092	K12171102	1000pF	E	
C1025	Ceramic Cap.	180pF	50V		C1093	K28129001	0.1uF	Y	
C1026	Ceramic Cap.	150pF	50V		C1094	K19149025	0.1uF	Y	
C1027	Ceramic Cap.	0.01uF	16V		C1095	K28129001	0.01uF	Y	
C1028	Al Electro Cap.	10uF	16V		C1097	K28129001	0.01uF	Y	
C1029	Ceramic Cap.	68pF	50V		C1098	K28129001	0.01uF	Y	
C1030	Ceramic Cap.	0.047uF	50V		C1099	K28129001	0.01uF	Y	
C1031	Ceramic Cap.	120pF	50V		C1100	K28129001	0.01uF	Y	
C1032	Ceramic Cap.	220pF	50V		C1102	K28129001	0.01uF	Y	
C1033	Ceramic Cap.	120pF	50V		C1103	K28129001	0.01uF	Y	
C1034	Ceramic Cap.	68pF	50V		C1104	K28129001	0.01uF	Y	
C1035	Ceramic Cap.	0.01uF	16V		C1105	K28129001	0.01uF	Y	
C1036	Al Electro Cap.	10uF	16V		C1106	K28129001	10pF	SL	
C1037	Ceramic Cap.	39pF	50V		C1107	K00173100	2.2uF	50V	
C1038	Ceramic Cap.	0.047uF	50V		C1108	K40179006	1000pF	B	
C1039	Ceramic Cap.	68pF	50V		C1109	K28179001	100pF	SL	
C1040	Ceramic Cap.	150pF	50V		C1110	K00175101	0.01uF	Y	
C1041	Ceramic Cap.	68pF	50V		C1111	K28129001	100pF	Y	
C1042	Ceramic Cap.	39pF	50V		C1112	K00175101	100pF	SL	
C1043	Ceramic Cap.								

For Service Manuals Contact
MAURITRON TECHNICAL SERVICES
 8 Cherry Tree Rd, Chinnor
 Oxon OX9 4QY
 Tel: 01844-351694 Fax: 01844-352554
 Email: enquiries@mauritron.co.uk

PARTS LIST

Part No.	Description	Value	Code	Vol	Capacitance	Material
C1113	Ceramic Cap.	22uF	SL	16V		
C1114	Ceramic Cap.	220pF	SL	50V		
C1115	Film Cap.	0.022uF		50V		
C1116	Al Electro Cap.	1uF	F	50V		
C1117	Ceramic Cap.	0.0047uF		50V		
C1118	Tantalum Cap.	1.5uF	Y	25V		
C1119	Ceramic Cap.	0.01uF	E	16V		
C1120	Ceramic Cap.	1000pF	Y	50V		
C1121	Ceramic Cap.	0.01uF	Y	16V		
C1122	Ceramic Cap.	0.01uF	Y	16V		
C1123	Ceramic Cap.	0.01uF	Y	16V		
C1124	Al Electro Cap.	1uF	Y	50V		
C1125	Al Electro Cap.	10uF		16V		
C1126	Al Electro Cap.	10uF		16V		
C1127	Al Electro Cap.	4.7uF		25V		
C1128	Film Cap.	0.001uF		50V		
C1129	Film Cap.	0.0022uF		50V		
C1130	Film Cap.	0.0047uF		50V		
C1131	Al Electro Cap.	10uF		16V		
C1132	Al Electro Cap.	0.0022uF		50V		
C1133	Film Cap.	4.7uF		25V		
C1134	Al Electro Cap.	10uF		16V		
C1135	Al Electro Cap.	0.47uF		50V		
C1136	Al Electro Cap.	1000pF		50V		
C1137	Ceramic Cap.	10uF		16V		
C1138	Al Electro Cap.	1uF		50V		
C1142	Ceramic Cap.	1000pF		50V		
C1144	Al Electro Cap.	1uF		50V		
C1145	Al Electro Cap.	1000pF		50V		
C1146	Ceramic Cap.	10uF		16V		
C1147	Ceramic Cap.	1000pF		16V		
C1148	Al Electro Cap.	10uF		16V		
C1149	Al Electro Cap.	4.7uF		25V		
C1150	Al Electro Cap.	0.01uF		16V		
C1151	Ceramic Cap.	22uF		16V		
C1152	Al Electro Cap.	1000pF		50V		
C1153	Ceramic Cap.	4.7uF		25V		
C1154	Al Electro Cap.	0.01uF		16V		
C1155	Ceramic Cap.	22pF		50V		
C1156	Ceramic Cap.	4.7uF		25V		
C1157	Ceramic Cap.	0.01uF		16V		
C1158	Ceramic Cap.	0.01uF		16V		
C1159	Ceramic Cap.	22pF		50V		
C1160	Ceramic Cap.	10uF		16V		
C1161	Al Electro Cap.	0.01uF		16V		
C1162	Ceramic Cap.	0.01uF		16V		
C1163	Ceramic Cap.	0.01uF		16V		
C1164	Ceramic Cap.	0.01uF		16V		
C1165	Ceramic Cap.	0.01uF		16V		
C1166	Ceramic Cap.	0.047uF		50V		
C1167	Ceramic Cap.	0.01uF		16V		
C1168	Ceramic Cap.	0.01uF		16V		
C1169	Ceramic Cap.	0.01uF		16V		
C1170	Ceramic Cap.	1000pF		50V		
C1171	Ceramic Cap.	1000pF		50V		
C1172	Ceramic Cap.	0.01uF		16V		
C1173	Ceramic Cap.	47pF		50V		
C1174	Ceramic Cap.	2pF		50V		
C1175	Ceramic Cap.	47pF		50V		
C1177	Ceramic Cap.	1000pF		50V		
C1178	Ceramic Cap.	1000pF		50V		
C1179	Ceramic Cap.	12pF		50V		
C1180	Ceramic Cap.	0.047uF		25V		
C1181	Ceramic Cap.	0.1uF		25V		
C1182	Ceramic Cap.	0.047uF		25V		
C1183	Film Cap.	0.022uF		50V		
C1184	Film Cap.	0.022uF		50V		
C1185	Film Cap.	4.7uF		25V		
C1186	Al Electro Cap.	10uF		16V		
C1187	Al Electro Cap.	0.01uF		50V		
C1188	Film Cap.	0.047uF		25V		
C1190	Ceramic Cap.	1500pF		25V		
C1191	Ceramic Cap.	0.1uF		25V		
C1192	Ceramic Cap.	0.047uF		25V		
C1193	Ceramic Cap.	0.1uF		25V		
C1194	Ceramic Cap.	0.047uF		50V		
C1195	Ceramic Cap.	0.047uF		50V		
C1196	Tantalum Cap.	0.22uF		40V		
C1197	Ceramic Cap.	0.01uF		16V		
C1198	Ceramic Cap.	10uF		16V		
C1200	Al Electro Cap.	0.47uF		50V		
C1201	Al Electro Cap.	0.47uF		25V		
C1202	Al Electro Cap.	4.7uF		16V		
C1203	Ceramic Cap.	0.01uF		16V		
C1204	Ceramic Cap.	1000pF		50V		
C1205	Ceramic Cap.	1000pF		50V		
C1206	Ceramic Cap.	1000pF		50V		
C1207	Ceramic Cap.	1000pF		50V		
C1208	Chip Cap.	0.01uF		50V		
C1209	Ceramic Cap.	0.047uF		25V		
C1210	Al Electro Cap.	100uF		16V		
C1211	Ceramic Cap.	470pF		50V		
C1212	Al Electro Cap.	470uF		16V		
C1213	Ceramic Cap.	0.047uF		50V		
C1214	Chip Cap.	0.01uF		50V		
C1215	Al Electro Cap.	10uF		16V		
C1216	Ceramic Cap.	100uF		16V		
C1217	Ceramic Cap.	10uF		16V		
C1218	Chip Cap.	0.01uF		16V		
C1219	Chip Cap.	0.047uF		50V		
C1220	Ceramic Cap.	51pF		50V		
C1221	Ceramic Cap.	51pF		50V		
C1222	Ceramic Cap.	0.01uF		16V		
C1223	Ceramic Cap.	0.01uF		16V		
C1224	Ceramic Cap.	22uF		16V		
C1225	Ceramic Cap.	0.01uF		16V		
C1226	Ceramic Cap.	0.068uF		25V		
C1227	Al Electro Cap.	2.2uF		50V		
C1228	Al Electro Cap.	1uF		50V		
C1229	Al Electro Cap.	22uF		16V		
C1230	Al Electro Cap.	10uF		16V		
C1231	Ceramic Cap.	47pF		50V		
C1232	Ceramic Cap.	56pF		50V		
C1233	Ceramic Cap.	1000pF		50V		
C1234	Ceramic Cap.	0.01uF		16V		
C1235	Al Electro Cap.	1uF		50V		
C1236	Al Electro Cap.	1uF		50V		
C1237	Al Electro Cap.	10uF		16V		
C1238	Al Electro Cap.	0.1uF		25V		
C1239	Ceramic Cap.	0.047uF		50V		
C1240	Ceramic Cap.	0.047uF		50V		

PARTS LIST

T1006	L0020858	Coil	48.0MHZ
T1007	L0021199	Coil	8.2MHZ
T1008	L0021199	Coil	8.2MHZ
T1009	L0021199	Coil	8.2MHZ
T1010	L0021199	Coil	8.2MHZ
T1011	L0021199	Coil	8.2MHZ
T1012	L0021199	Coil	8.2MHZ
T1013	L0021192	Coil	8.2MHZ
T1014	L0021199	Coil	8.2MHZ
T1015	L0021199	Coil	8.2MHZ
T1016	L0021195	Coil	8.21MHZ
T1017	L0021225	Coil	47.1MHZ
T1018	L0021225	Coil	47.1MHZ
T1019	L0021225	Coil	47.1MHZ
T1020	L0020788A	Coil	47.1MHZ
T1021	L0020788A	Coil	47.1MHZ
PL1001	M1190056	Relay	FBR21D12 (DC12V)
S1001	N6090033	Slide Switch	
S1002	N6090033	Slide Switch	

For Service Manuals Contact
MAURITRON TECHNICAL SERVICES
 8 Cherry Tree Rd, Chinner
 Oxon OX9 4QY
 Tel:- 01844-351694 Fax:- 01844-352554
 Email:- enquiries@mauritron.co.uk

CB1001	K80000013	Block Cap.	0.1uF X 7	50V
L1001	L1190227	RFC	560uH	
L1002	L0021221	Coil	0.017uH	
L1003	L0021222	Coil	0.24uH	
L1004	L1190220	RFC	150uH	
L1006	L1190210	RFC	22uH	
L1008	L1190210	RFC	22uH	
L1009	L1190189	RFC	1mH	
L1010	L1190209	RFC	18uF	
L1011	L1190208	RFC	15uF	
L1012	L1190205	RFC	6.8uF	
L1013	L1190208	RFC	15uF	
L1014	L1190209	RFC	18uF	
L1015	L1190207	RFC	12uF	
L1016	L1190206	RFC	8.2uF	
L1017	L1190202	RFC	3.9uF	
L1018	L1190206	RFC	8.2uF	
L1019	L1190207	RFC	12uF	
L1020	L1190205	RFC	6.8uF	
L1021	L1190199	RFC	4.7uF	
L1022	L1190199	RFC	2.2uF	
L1023	L1190203	RFC	4.7uF	
L1024	L1190205	RFC	6.8uF	
L1025	L1190200	RFC	2.7uF	
L1026	L1190202	RFC	3.9uF	
L1027	L1190195	RFC	0.82uF	
L1028	L1190202	RFC	2.7uF	
L1029	L1190200	RFC	3.9uF	
L1030	L1190198	RFC	1.8uF	
L1031	L1190199	RFC	2.2uF	
L1032	L1190192	RFC	0.47uF	
L1033	L1190199	RFC	2.2uF	
L1034	L1190198	RFC	1.8uF	
L1035	L1190189	RFC	1mH	
L1036	L1190187	RFC	1.5uH	
L1037	L1190220	RFC	150uH	
L1038	L1190220	RFC	150uH	
L1039	L1190040	RFC	1mH	
L1040	L1190220	RFC	150uH	
L1041	L1190188	RFC	0.22uH	
L1042	L1190090	RFC	1mH	
L1043	L1190218	RFC	100uH	
L1044	L1190204	RFC	5.6uH	
L1045	L1190214	RFC	47uH	
L1046	L1190218	RFC	100uH	
L1047	L1190123	RFC	3.9mH	
L1048	L1190040	RFC	1mH	
L1049	L1190123	RFC	3.9mH	
L1050	L1190218	RFC	100uH	
L1052	L1190220	RFC	150uH	
L1053	L1190037	RFC	150uH	
L1054	L1190190	RFC	0.27uH	
L1056	L1190189	RFC	1mH	
L1057	L1190190	RFC	0.27uH	
L1058	L1190148	RFC	10uH	
T1001	L0020788A	Coil	47.1MHZ	
T1002	L0021351	Coil	47.1MHZ	
T1003	L0020225	Coil	47.1MHZ	
T1004	L0020224	Coil	47.0MHZ	
T1005	L0020482	Coil	47.0MHZ	

PARTS LIST

NB UNIT		LOCAL UNIT	
CP1256001 F2949101		PCB with Components w/ PLL-LPF UNIT PCB with Components w/o PLL-LPF UNIT	
Printed Circuit Board		Printed Circuit Board	
Q8101	G4800740L	FET	3SK74L
Q8102	G3803027Y	FET	2SK302Y TE85R
Q8103	G3330527F	Transistor	2SC3052-T14-2F
Q8104	G3330527F	Transistor	2SC3052-T14-2F
D8101	G2090244	Diode	1SS106
D8102	G2090244	Diode	1SS106
D8103	G2070009	Diode	1SS184 TE85R
R8101	J24205103	Chip Res.	10k ohm 1/10W
R8102	J24205473	Chip Res.	47k ohm 1/10W
R8103	J24205101	Chip Res.	100 ohm 1/10W
R8104	J24205153	Chip Res.	15k ohm 1/10W
R8105	J24205101	Chip Res.	100 ohm 1/10W
R8106	J24205104	Chip Res.	100k ohm 1/10W
R8108	J24205101	Chip Res.	100 ohm 1/10W
R8109	J24205102	Chip Res.	1k ohm 1/10W
R8110	J24205222	Chip Res.	2.2k ohm 1/10W
R8111	J24205223	Chip Res.	22k ohm 1/10W
R8112	J24205102	Chip Res.	1k ohm 1/10W
R8113	J24205224	Chip Res.	220k ohm 1/10W
R8114	J24205472	Chip Res.	4.7k ohm 1/10W
R8115	J24205472	Chip Res.	4.7k ohm 1/10W
R8116	J24205000	Chip Res.	0 ohm 1/10W
C8101	K22170235	Chip Cap.	100pF 50V CH
C8102	K22171004	Chip Cap.	0.01uF 50V F
C8103	K22171004	Chip Cap.	0.01uF 50V F
C8104	K22171004	Chip Cap.	0.01uF 50V F
C8105	K22171004	Chip Cap.	0.01uF 50V F
C8106	K22170219	Chip Cap.	22pF 50V CH
C8107	K22171004	Chip Cap.	0.01uF 50V F
C8108	K22170243	Chip Cap.	220pF 50V CH
C8109	K22170243	Chip Cap.	220pF 50V CH
C8110	K40129004	Al Electro Cap.	10uF 16V
C8111	K40129004	Al Electro Cap.	10uF 16V
C8112	K22171004	Chip Cap.	0.01uF 50V F
C8113	K40129004	Al Electro Cap.	10uF 16V
C8114	K22170235	Chip Cap.	100pF 50V CH
C8115	K22171004	Chip Cap.	0.01uF 50V F
L8101	L1190189	RFC	
T8101	L00221199	Coil	8.20MHZ
T8102	L00221199	Coil	8.20MHZ
J8101	P0090481	Connector	
Q2001	G1090297	IC	uPD4094BC
Q2002	G1090836	IC	M56564P
Q2003	G3305350B	Transistor	2SC535B
Q2004	G3304580C	Transistor	2SC458C
Q2005	G3304580C	Transistor	2SC458C
Q2006	G3304580C	Transistor	2SC458C
Q2007	G3304580C	Transistor	2SC458C
Q2008	G3304580C	Transistor	2SC458C
Q2009	G1090012	IC	SN16913P
Q2010	G3304580C	Transistor	2SC458C
Q2011	G3304580C	Transistor	2SC458C
Q2012	G1090012	IC	SN16913P
Q2013	G1090838	IC	M54459L
Q2014	G1090280	IC	uPD4013BC
Q2015	G3304580C	Transistor	2SC458C
Q2016	G3305350B	Transistor	2SC535B
Q2017	G3801921G	Transistor	2SK192AGR
Q2018	G1090834	IC	CX-1925B
Q2019	G3801840Y	FET	2SK184Y
Q2020	G3307320B	Transistor	2SC732TMBL
Q2021	G1090101	IC	uPC1037H
Q2022	G3305350B	Transistor	2SC535B
Q2024	G1090834	IC	CX-7925B
Q2025	G3304580C	Transistor	2SC458C
Q2026	G3801840Y	FET	2SK184Y
Q2027	G3307320B	Transistor	2SC732TMBL
Q2028	G3305350B	Transistor	2SC535B
Q2029	G3305350B	Transistor	2SC535B
Q2030	G3305350B	Transistor	2SC535B
Q2031	G3305350B	Transistor	2SC535B
Q2032	G3305350B	Transistor	2SC535B
Q2034	G3320530	Transistor	2SC2053
D2001	G2090408	Diode	1SS270
D2002	G2090408	Diode	1SS270
D2003	G2090027	Diode	1SS53
D2004	G2090027	Diode	1SS53
D2005	G2090180	Diode	FC-52M-5
D2006	G2090408	Diode	1SS270
D2007	G2060004	Diode	1SS270 TJ
D2008	G2090161	Diode	1SV55
D2009	G2090237	Diode	MA190
D2010	G2090027	Diode	1SS53
D2011	G2090161	Diode	1SV55
D2012	G2090027	Diode	1SS53
D2013	G2090161	Diode	1SV55
D2014	G2090027	Diode	1SS53
D2015	G2090161	Diode	1SV55
D2016	G2090027	Diode	1SS53
X2001	H0102853	Crystal	HC-48/U 38.840MHZ
X2002	H0102852	Crystal	HC-48/U 8.2165MHZ
X2003	H0102851	Crystal	HC-48/U 8.2135MHZ
X2004	H0102850	Crystal	HC-48/U 5.400MHZ

PARTS LIST

CF2001	H3900390	Ceramic Filter	SFT-5-74MA	R2061	J01225221	Carbon Film Res.	220 ohm	1/6W	PJ
R2001	J02225472	Carbon Film Res.	4.7k ohm	R2062	J01225221	Carbon Film Res.	220 ohm	1/6W	PJ
R2002	J02225472	Carbon Film Res.	4.7k ohm	R2063	J02225101	Carbon Film Res.	100 ohm	1/6W	UJ
R2003	J02225101	Carbon Film Res.	100 ohm	R2064	J02225104	Carbon Film Res.	100k ohm	1/6W	UJ
R2004	J02225471	Carbon Film Res.	470 ohm	R2065	J02225471	Carbon Film Res.	470 ohm	1/6W	UJ
R2005	J02225154	Carbon Film Res.	150k ohm	R2066	J02225221	Carbon Film Res.	220 ohm	1/6W	UJ
R2006	J02225101	Carbon Film Res.	100 ohm	R2067	J02225221	Carbon Film Res.	220 ohm	1/6W	PJ
R2007	J02225471	Carbon Film Res.	470 ohm	R2068	J02225221	Carbon Film Res.	220 ohm	1/6W	PJ
R2008	J02225683	Carbon Film Res.	68k ohm	R2075	J02225103	Carbon Film Res.	10k ohm	1/6W	UJ
R2009	J02225470	Carbon Film Res.	47 ohm	R2076	J02225103	Carbon Film Res.	10k ohm	1/6W	UJ
R2010	J02225101	Carbon Film Res.	100 ohm	R2077	J02225104	Carbon Film Res.	100k ohm	1/6W	UJ
R2011	J02225103	Carbon Film Res.	10k ohm	R2078	J02225182	Carbon Film Res.	6.8k ohm	1/6W	UJ
R2012	J02225101	Carbon Film Res.	100 ohm	R2079	J01225182	Carbon Film Res.	1.8k ohm	1/6W	PJ
R2013	J02225101	Carbon Film Res.	100 ohm	R2080	J01225272	Carbon Film Res.	2.7k ohm	1/6W	UJ
R2014	J02225472	Carbon Film Res.	4.7k ohm	R2081	J01225101	Carbon Film Res.	100 ohm	1/6W	UJ
R2015	J02225472	Carbon Film Res.	4.7k ohm	R2082	J02225152	Carbon Film Res.	1.5k ohm	1/6W	PJ
R2016	J02225102	Carbon Film Res.	1k ohm	R2083	J01225332	Carbon Film Res.	3.3k ohm	1/6W	UJ
R2017	J02225223	Carbon Film Res.	22k ohm	R2084	J02225223	Carbon Film Res.	22k ohm	1/6W	UJ
R2018	J02225103	Carbon Film Res.	10k ohm	R2085	J02225104	Carbon Film Res.	10k ohm	1/6W	UJ
R2019	J02225102	Carbon Film Res.	10k ohm	R2086	J02225103	Carbon Film Res.	10k ohm	1/6W	UJ
R2020	J02225683	Carbon Film Res.	68k ohm	R2087	J02225103	Carbon Film Res.	10k ohm	1/6W	UJ
R2021	J01225470	Carbon Film Res.	47 ohm	R2088	J02225101	Carbon Film Res.	10k ohm	1/6W	UJ
R2022	J01225101	Carbon Film Res.	100 ohm	R2089	J02225103	Carbon Film Res.	10k ohm	1/6W	UJ
R2023	J02225101	Carbon Film Res.	100 ohm	R2090	J02225223	Carbon Film Res.	100k ohm	1/6W	UJ
R2024	J02225223	Carbon Film Res.	22k ohm	R2091	J02225104	Carbon Film Res.	10k ohm	1/6W	UJ
R2025	J02225103	Carbon Film Res.	10k ohm	R2092	J02225103	Carbon Film Res.	10k ohm	1/6W	UJ
R2026	J01225470	Carbon Film Res.	47 ohm	R2093	J02225103	Carbon Film Res.	10k ohm	1/6W	UJ
R2027	J02225471	Carbon Film Res.	470 ohm	R2094	J02225103	Carbon Film Res.	10k ohm	1/6W	UJ
R2028	J01225101	Carbon Film Res.	100 ohm	R2095	J02225101	Carbon Film Res.	100 ohm	1/6W	UJ
R2029	J01225101	Carbon Film Res.	100 ohm	R2096	J02225223	Carbon Film Res.	22k ohm	1/6W	UJ
R2030	J02225471	Carbon Film Res.	470 ohm	R2097	J02225104	Carbon Film Res.	100k ohm	1/6W	UJ
R2031	J02225470	Carbon Film Res.	47 ohm	R2098	J02225103	Carbon Film Res.	10k ohm	1/6W	UJ
R2032	J02225223	Carbon Film Res.	22k ohm	R2099	J02225103	Carbon Film Res.	10k ohm	1/6W	UJ
R2033	J02225103	Carbon Film Res.	10k ohm	R2100	J02225103	Carbon Film Res.	10k ohm	1/6W	UJ
R2034	J01225681	Carbon Film Res.	680 ohm	R2101	J02225101	Carbon Film Res.	100 ohm	1/6W	UJ
R2035	J01225101	Carbon Film Res.	100 ohm	R2102	J02225223	Carbon Film Res.	22k ohm	1/6W	UJ
R2036	J02225472	Carbon Film Res.	4.7k ohm	R2103	J02225104	Carbon Film Res.	100k ohm	1/6W	UJ
R2037	J02225472	Carbon Film Res.	4.7k ohm	R2104	J02225103	Carbon Film Res.	10k ohm	1/6W	UJ
R2038	J02225681	Carbon Film Res.	680 ohm	R2105	J02225153	Carbon Film Res.	15k ohm	1/6W	UJ
R2039	J02225101	Carbon Film Res.	100 ohm	R2106	J02225103	Carbon Film Res.	10k ohm	1/6W	UJ
R2040	J02225471	Carbon Film Res.	470 ohm	R2107	J02225471	Carbon Film Res.	470 ohm	1/6W	UJ
R2041	J02225154	Carbon Film Res.	150k ohm	R2108	J02225104	Carbon Film Res.	100k ohm	1/6W	UJ
R2042	J02225153	Carbon Film Res.	15k ohm	R2109	J02225101	Carbon Film Res.	100 ohm	1/6W	UJ
R2043	J02225101	Carbon Film Res.	100 ohm	R2110	J02225471	Carbon Film Res.	470 ohm	1/6W	UJ
R2044	J02225471	Carbon Film Res.	470 ohm	R2111	J02225681	Carbon Film Res.	680 ohm	1/6W	UJ
R2045	J02225104	Carbon Film Res.	100k ohm	R2112	J02225471	Carbon Film Res.	470 ohm	1/6W	UJ
R2046	J01225101	Carbon Film Res.	100 ohm	R2113	J02225100	Carbon Film Res.	10 ohm	1/6W	UJ
R2047	J02225331	Carbon Film Res.	330 ohm	R2114	J02225560	Carbon Film Res.	56 ohm	1/6W	UJ
R2048	J02225104	Carbon Film Res.	100k ohm	R2116	J02225471	Carbon Film Res.	470 ohm	1/6W	UJ
R2049	J02225223	Carbon Film Res.	22k ohm	R2120	J01225560	Carbon Film Res.	56 ohm	1/6W	PJ
R2050	J01225332	Carbon Film Res.	3.3k ohm	TH2001	G9090008	Thermistor	11-2102-2		
R2051	J02225103	Carbon Film Res.	10k ohm	C2001	K12171102	Ceramic Cap.	1000pF	50V	E
R2052	J02225272	Carbon Film Res.	2.7k ohm	C2002	K02175560	Ceramic Cap.	56pF	50V	CH
R2053	J02225272	Carbon Film Res.	2.7k ohm	C2003	K02175150	Ceramic Cap.	15pF	50V	CH
R2054	J02225101	Carbon Film Res.	100 ohm	C2004	K12171102	Ceramic Cap.	1000pF	50V	E
R2055	J01225273	Carbon Film Res.	27k ohm	C2005	K02172059	Ceramic Cap.	0.5pF	50V	CH
R2056	J01225182	Carbon Film Res.	1.8k ohm	C2006	K02175120	Ceramic Cap.	12pF	50V	CH
R2057	J02225152	Carbon Film Res.	1.5k ohm	C2007	K28179001	Ceramic Cap.	1000pF	50V	B
R2058	J01225103	Carbon Film Res.	10k ohm	C2008	K02172030	Ceramic Cap.	3pF	50V	CH
R2059	J01225221	Carbon Film Res.	220 ohm	C2009	K12171102	Ceramic Cap.	1000pF	50V	E
R2060	J01225221	Carbon Film Res.	220 ohm						

For Service Manuals Contact
MAURITRON TECHNICAL SERVICES
 8 Cherry Tree Rd, Chinnor
 Oxon OX9 4QY
 Tel: 01844-351694 Fax: 01844-352554
 Email: enquiries@mauritron.co.uk

PARTS LIST

C2010	K12171102	Ceramic Cap.	1000pF	50V	E	C2072	K19149017	Ceramic Cap.	0.022uF	25V	B
C2011	K28129001	Ceramic Cap.	0.01uF	16V	Y	C2073	K19149019	Ceramic Cap.	0.033uF	25V	B
C2012	K28129001	Ceramic Cap.	0.01uF	16V	Y	C2074	K40129008	Al Electro Cap.	33uF	16V	B
C2013	K28129001	Ceramic Cap.	0.01uF	16V	Y	C2075	K10179101	Ceramic Cap.	100pF	50V	B
C2014	K02175150	Ceramic Cap.	15pF	50V	CH	C2076	K10176101	Ceramic Cap.	100pF	50V	B
C2015	K02173100	Ceramic Cap.	10pF	50V	CH	C2077	K10176101	Ceramic Cap.	100pF	50V	B
C2016	K02175150	Ceramic Cap.	15pF	50V	CH	C2078	K19149005	Ceramic Cap.	0.0022uF	25V	E
C2017	K28129001	Ceramic Cap.	0.01uF	16V	Y	C2079	K12171102	Ceramic Cap.	1000pF	50V	E
C2018	K02175121	Ceramic Cap.	120pF	50V	CH	C2080	K28129001	Ceramic Cap.	0.01uF	16V	Y
C2019	K02175820	Ceramic Cap.	82pF	50V	CH	C2082	K28129001	Ceramic Cap.	0.01uF	16V	Y
C2020	K28129001	Ceramic Cap.	0.01uF	16V	Y	C2084	K12171102	Ceramic Cap.	1000pF	50V	E
C2021	K02173080	Ceramic Cap.	8pF	50V	CH	C2085	K12171102	Ceramic Cap.	1000pF	50V	E
C2022	K02172050	Ceramic Cap.	5pF	50V	CH	C2086	K02179001	Ceramic Cap.	1pF	50V	CH
C2023	K19149021	Ceramic Cap.	0.047uF	25V	Y	C2087	K02172020	Ceramic Cap.	2pF	50V	CH
C2024	K28129001	Ceramic Cap.	0.01uF	16V	Y	C2101	K10176101	Ceramic Cap.	100pF	50V	B
C2025	K28179001	Ceramic Cap.	1000pF	50V	Y	C2102	K10176101	Ceramic Cap.	100pF	50V	B
C2026	K28129001	Ceramic Cap.	0.01uF	16V	Y	C2103	K10176101	Ceramic Cap.	100pF	50V	B
C2027	K28129001	Ceramic Cap.	0.01uF	16V	Y	C2104	K06179007	Ceramic Cap.	36pF	50V	UJ
C2028	K28129001	Ceramic Cap.	0.01uF	16V	Y	C2105	K06175390	Ceramic Cap.	39pF	50V	UJ
C2029	K28129001	Ceramic Cap.	0.01uF	16V	Y	C2106	K40129004	Al Electro Cap.	10uF	16V	Y
C2030	K28129001	Ceramic Cap.	0.01uF	16V	Y	C2107	K40129008	Al Electro Cap.	33uF	16V	Y
C2031	K12171102	Ceramic Cap.	0.5pF	50V	E	C2108	K28129001	Ceramic Cap.	0.01uF	16V	Y
C2032	K00179001	Ceramic Cap.	3pF	50V	SL	C2109	K28129001	Ceramic Cap.	0.01uF	16V	Y
C2033	K00172030	Ceramic Cap.	1000pF	50V	E	C2111	K19149025	Ceramic Cap.	0.01uF	25V	Y
C2034	K12171102	Ceramic Cap.	1000pF	50V	E	C2112	K40129038	Al Electro Cap.	100uF	16V	Y
C2035	K12171102	Ceramic Cap.	0.01uF	16V	Y	C2114	K19149013	Ceramic Cap.	0.01uF	25V	E
C2036	K28129001	Ceramic Cap.	100pF	50V	SL	C2115	K06179008	Ceramic Cap.	1000pF	50V	UJ
C2037	K00175101	Ceramic Cap.	10pF	50V	SL	C2116	K02173070	Ceramic Cap.	43uF	50V	CH
C2038	K00173100	Ceramic Cap.	0.01uF	16V	Y	C2117	K06172050	Ceramic Cap.	7uF	50V	UJ
C2039	K28129001	Ceramic Cap.	0.01uF	16V	Y	C2118	K06175330	Ceramic Cap.	5uF	50V	UJ
C2040	K28129001	Ceramic Cap.	0.01uF	16V	Y	C2119	K06175150	Ceramic Cap.	15uF	50V	UJ
C2041	K28129001	Ceramic Cap.	0.01uF	16V	Y	C2120	K12171102	Ceramic Cap.	1000pF	50V	E
C2042	K28129001	Ceramic Cap.	0.01uF	16V	Y	C2121	K12171102	Ceramic Cap.	1000pF	50V	E
C2043	K40129004	Al Electro Cap.	0.01uF	50V	Y	C2122	K40129008	Al Electro Cap.	33uF	16V	UJ
C2044	K28129001	Ceramic Cap.	0.01uF	50V	Y	C2123	K06175470	Ceramic Cap.	47pF	50V	UJ
C2045	K28129001	Ceramic Cap.	0.01uF	16V	Y	C2124	K06172050	Ceramic Cap.	5pF	50V	UJ
C2046	K28129001	Ceramic Cap.	560pF	50V	B	C2125	K05175330	Ceramic Cap.	33pF	50V	RH
C2047	K10176561	Ceramic Cap.	270pF	50V	B	C2126	K02173100	Ceramic Cap.	10pF	50V	CH
C2048	K10176271	Ceramic Cap.	1000pF	50V	B	C2127	K12171102	Ceramic Cap.	1000pF	50V	E
C2049	K10176102	Ceramic Cap.	1000pF	16V	B	C2128	K40129008	Al Electro Cap.	33uF	16V	UJ
C2050	K10176101	Ceramic Cap.	680pF	50V	B	C2129	K06175390	Ceramic Cap.	39pF	50V	UJ
C2051	K10176681	Ceramic Cap.	0.01uF	16V	Y	C2130	K06172050	Ceramic Cap.	5pF	50V	UJ
C2052	K28129001	Ceramic Cap.	0.047uF	50V	F	C2131	K06175220	Ceramic Cap.	22pF	50V	UJ
C2053	K13179014	Ceramic Cap.	27pF	50V	SL	C2132	K06172050	Ceramic Cap.	5pF	50V	UJ
C2054	K00175270	Ceramic Cap.	0.01uF	16V	Y	C2133	K12171102	Ceramic Cap.	1000pF	50V	E
C2055	K28129001	Ceramic Cap.	0.01uF	16V	Y	C2134	K40129008	Al Electro Cap.	33uF	16V	UJ
C2056	K28129001	Ceramic Cap.	0.01uF	16V	Y	C2135	K06179008	Ceramic Cap.	43pF	16V	UJ
C2057	K28129001	Ceramic Cap.	0.01uF	16V	Y	C2136	K05172050	Ceramic Cap.	5pF	50V	RH
C2058	K12171102	Ceramic Cap.	1000pF	50V	E	C2137	K05175180	Ceramic Cap.	18pF	50V	RH
C2059	K12171102	Ceramic Cap.	1000pF	50V	E	C2138	K05172050	Ceramic Cap.	5pF	50V	RH
C2060	K40129008	Al Electro Cap.	33uF	16V	E	C2139	K12171102	Ceramic Cap.	1000pF	50V	E
C2061	K12171102	Ceramic Cap.	1000pF	50V	CH	C2140	K40129008	Al Electro Cap.	33uF	16V	E
C2062	K02179001	Ceramic Cap.	1pF	50V	RH	C2141	K12171102	Ceramic Cap.	1000pF	50V	E
C2063	K05173080	Ceramic Cap.	8pF	50V	CH	C2142	K12171102	Ceramic Cap.	3pF	50V	E
C2064	K02175270	Ceramic Cap.	27pF	50V	CH	C2143	K02172030	Ceramic Cap.	1000pF	50V	E
C2065	K02175150	Ceramic Cap.	15pF	50V	CH	C2144	K12171102	Ceramic Cap.	3pF	50V	E
C2066	K06175220	Ceramic Cap.	22pF	50V	UJ	C2145	K12171102	Ceramic Cap.	1000pF	50V	CH
C2067	K02173100	Ceramic Cap.	10pF	50V	CH	C2146	K10176331	Ceramic Cap.	330pF	50V	E
C2068	K40179013	Al Electro Cap.	1uF	50V	Y	C2148	K00175270	Ceramic Cap.	27pF	50V	SL
C2069	K28129001	Ceramic Cap.	0.01uF	16V	Y	C2149	K00175560	Ceramic Cap.	56pF	50V	SL
C2070	K40129008	Al Electro Cap.	33uF	16V	Y	C2150	K00175270	Ceramic Cap.	27pF	50V	SL
C2071	K28129001	Ceramic Cap.	0.01uF	16V	Y						

PARTS LIST

PLL-LPF UNIT		PCB with Components		Printed Circuit Board	
CP1261001		F2971101A		2SC2620QBTR	
Q7023	G3326207B	Transistor			
R7069	J24205331	Chip Res.	330 ohm	1/10W	B
R7070	J24205104	Chip Res.	100k ohm	1/10W	CH
R7071	J24205102	Chip Res.	1k ohm	1/10W	CH
R7072	J24205101	Chip Res.	100 ohm	1/10W	CH
R7073	J24205101	Chip Res.	100 ohm	1/10W	CH
C7081	K22170817	Chip Cap.	0.01uF	50V	B
C7088	K22170209	Chip Cap.	8pF	50V	CH
C7089	K22170204	Chip Cap.	3pF	50V	CH
C7090	K22170220	Chip Cap.	24pF	50V	CH
C7092	K22170219	Chip Cap.	22pF	50V	CH
C7093	K22170210	Chip Cap.	9pF	50V	CH
C7094	K22170219	Chip Cap.	22pF	50V	CH
C7095	K22170206	Chip Cap.	5pF	50V	CH
C7096	K22170221	Chip Cap.	27pF	50V	CH
C7097	K22170201	Chip Cap.	0.5pF	50V	CH
C7098	K22170817	Chip Cap.	0.01uF	50V	B
C7099	K22170817	Chip Cap.	0.01uF	50V	B
C7100	K22170817	Chip Cap.	0.01uF	50V	B
C7156	K22170213	Chip Cap.	12pF	50V	CH
L7022	L1190218	RFC	100uH		
T7010	L0021553	Coil			
T7011	L0021554	Coil			
T7012	L0021554	Coil			
T7013	L0021553	Coil			
T7014	L0021555	Coil			

C2151	K00179013	Ceramic Cap.	91pF	50V	SL
C2152	K00175470	Ceramic Cap.	47pF	50V	SL
C2153	K00179013	Ceramic Cap.	91pF	50V	SL
C2154	K00175560	Ceramic Cap.	56pF	50V	SL
C2155	K00175560	Ceramic Cap.	56pF	50V	SL
C2157	K28129001	Ceramic Cap.	0.01uF	16V	Y
C2158	K12171102	Ceramic Cap.	1000pF	50V	E
C2159	K12171102	Ceramic Cap.	1000pF	50V	E
C2161	K00175101	Ceramic Cap.	100pF	50V	SL
C2162	K28129001	Ceramic Cap.	0.01uF	16V	Y
C2163	K13179009	Ceramic Cap.	0.047uF	50V	F
C2164	K19149025	Ceramic Cap.	0.1uF	25V	F
C2165	K00175470	Ceramic Cap.	47pF	50V	SL
C2166	K10176331	Ceramic Cap.	330pF	50V	B
TC2001	K91000141	Trimmer Cap.	10pF		
TC2002	K91000142	Trimmer Cap.	20pF		
TC2003	K91000142	Trimmer Cap.	20pF		
TC2004	K91000186	Trimmer Cap.	20pF		
L2001	L1190223	RFC	270uH		
L2002	L1190024	RFC	220uH		
L2003	L1190038	RFC	270uH		
L2004	L1190005	RFC	1uH		
L2010	L1190029	RFC	47uH		
L2011	L1190014	RFC	10uH		
L2012	L1190011	RFC	4.7uH		
L2013	L1190005	RFC	1uH		
L2014	L0021410	Coil	0.147uH		
L2015	L0021410	Coil	0.147uH		
L2016	L0021409	Coil	0.117uH		
L2017	L0021409	Coil	0.117uH		
L2018	L1190190	RFC	0.27uH		
L2020	L1190218	RFC	100uH		
L2021	L1190218	RFC	100uH		
T2001	L0021862	Coil	44.6MHZ		
T2002	L0021862	Coil	44.6MHZ		
T2003	L0021862	Coil	44.6MHZ		
T2004	L0021861	Coil	5.74MHZ		
T2005	L0021380	Coil	0.40uH		
T2006	L0021860	Coil	0.45uH		
T2007	L0021380	Coil	0.40uH		
T2008	L0021380	Coil	0.40uH		
T2009	L0021382	Coil	0.29uH		
J2001	P0090627	Connector			
J2002	P1090554	Connector			
J2003	P1090594	Connector			
T9317814	T9317814	Wire Assy	P2001		
T9317813	T9317813	Wire Assy	P2002		
T9317812	T9317812	Wire Assy	P2003		
R0124120	R0124120	VCO Case			
R0124130	R0124130	VCO Cover			
R0124140A	R0124140A	Shield Plate			
R0124150A	R0124150A	Shield Plate			
R0124160B	R0124160B	Shield Plate			
R0123770	R0123770	Ground Lead			
R0125800	R0125800	Leaf Spring			

For Service Manuals Contact
MAURITRON TECHNICAL SERVICES
 8 Cherry Tree Rd, Chinnor
 Oxon OX9 4QY
 Tel: 01844-351694 Fax: 01844-352554
 Email: enquiries@mauritron.co.uk

PARTS LIST

Part No.	Description	Quantity	Notes
R3035	Carbon Film Res.	1/6W	PJ
R3036	Carbon Film Res.	1/6W	PJ
R3037	Carbon Film Res.	1/6W	PJ
R3038	Carbon Film Res.	1/6W	PJ
R3039	Carbon Film Res.	1/6W	PJ
R3040	Carbon Film Res.	1/6W	PJ
R3041	Carbon Film Res.	1/6W	PJ
R3042	Carbon Film Res.	1/6W	PJ
R3043	Carbon Film Res.	1/6W	PJ
R3044	Carbon Film Res.	1/6W	PJ
R3045	Carbon Film Res.	1/6W	PJ
R3046	Carbon Film Res.	1/6W	PJ
R3047	Carbon Film Res.	1/6W	PJ
RB3001	Block Res.	47k x 8	
C3001	Ceramic Cap.	0.01uF	Y
C3002	Al Electro Cap.	10uF	Y
C3003	Ceramic Cap.	0.01uF	
C3004	Al Electro Cap.	10uF	
C3005	Al Electro Cap.	0.22uF	Y
C3006	Ceramic Cap.	0.01uF	Y
C3007	Ceramic Cap.	0.01uF	Y
C3008	Ceramic Cap.	0.01uF	Y
C3009	Ceramic Cap.	0.01uF	Y
C3010	Ceramic Cap.	0.01uF	Y
C3011	Ceramic Cap.	0.01uF	SL
C3012	Ceramic Cap.	15pF	SL
C3013	Al Electro Cap.	0.47uF	Y
C3014	Ceramic Cap.	0.01uF	
C3015	Ceramic Cap.	0.1uF	
C3016	Al Electro Cap.	47uF	
C3017	Al Electro Cap.	100uF	
C3018	Ceramic Cap.	470uF	
C3019	Al Electro Cap.	0.1uF	Y
C3020	Film Cap.	0.1uF	
C3021	Al Electro Cap.	470uF	
C3022	Ceramic Cap.	0.01uF	
C3023	Al Electro Cap.	10uF	
C3025	Ceramic Cap.	0.068uF	
C3026	Al Electro Cap.	10uF	Y
C3027	Ceramic Cap.	0.01uF	F
C3028	Ceramic Cap.	0.047uF	F
C3029	Ceramic Cap.	0.047uF	F
C3030	Al Electro Cap.	0.47uF	
C3034	Al Electro Cap.	0.74uF	
C3035	Al Electro Cap.	10uF	
C3036	Ceramic Cap.	0.0.1uF	F
C3037	Al Electro Cap.	1uF	
S3001	Rotary Code Switch		
S3002	Switch	KEG10904	
S3003	Switch	KEG10904	
S3004	Switch	KEG10904	
S3005	Switch	KEG10904	
S3006	Switch	KEG10904	
S3007	Switch	KEG10904	
S3008	Switch	KEG10904	
S3009	Switch	KEG10904	
S3010	Switch	KEG10904	
S3011	Switch	KEG10904	
S3012	Switch	KEG10904	

Part No.	Description	Quantity	Notes
CS002.4002	PCB with Components		
F2943102D	Printed Circuit Board		
Q3001	IC	M50932-117FP	
Q3002	IC	TDA2003H	
Q3003	IC	uPC7805H	
Q3004	IC	M51943BSL	
Q3005	Transistor	BA1A4M	
Q3006	Transistor	BA1A4M	
Q3007	Transistor	BA1A4P	
Q3008	Transistor	2SD667C	
Q3009	Transistor	2SC458C	
Q3014	Transistor	BA1A4P	
D3001	Diode	1SS97	
D3002	Diode	GL9PR4	
D3005	Diode	1SS270	
D3007	Diode	1SS270TJ	
D3008	Diode	1SS97	
D3009	Diode	GL-8PG25	
D3010	Diode	1SS270TJ	
D3011	Diode	1SS270TJ	
D3012	Diode	1SS270TJ	
D3013	Diode	1SS270TJ	
DS3001	LCD	FTD8627PZ	
CO3001	Ceramic Filter	CSA400MG5	
R3001	Carbon Film Res.	390 ohm	PJ
R3004	Carbon Film Res.	1M ohm	1/6W PJ
R3006	Carbon Film Res.	100 ohm	1/6W PJ
R3007	Carbon Film Res.	10k ohm	1/6W PJ
R3008	Carbon Film Res.	47k ohm	1/6W PJ
R3009	Carbon Film Res.	1k ohm	1/6W PJ
R3010	Carbon Film Res.	100k ohm	1/6W PJ
R3011	Carbon Film Res.	10k ohm	1/6W PJ
R3012	Carbon Film Res.	4.7k ohm	1/6W PJ
R3014	Carbon Film Res.	100k ohm	1/6W PJ
R3015	Carbon Film Res.	47k ohm	1/6W PJ
R3017	Carbon Film Res.	4.7k ohm	1/6W PJ
R3018	Carbon Film Res.	10k ohm	1/6W PJ
R3019	Carbon Film Res.	10k ohm	1/6W PJ
R3020	Carbon Film Res.	10k ohm	1/6W PJ
R3021	Carbon Film Res.	47k ohm	1/6W PJ
R3022	Carbon Film Res.	100 ohm	1/6W PJ
R3023	Carbon Film Res.	100 ohm	1/6W PJ
R3024	Carbon Film Res.	47 ohm	1/6W PJ
R3025	Carbon Film Res.	1 ohm	1/6W PJ
R3026	Carbon Film Res.	2.2 ohm	1/6W PJ
R3027	Carbon Film Res.	220 ohm	1/6W PJ
R3028	Carbon Film Res.	100k ohm	1/6W PJ
R3029	Carbon Film Res.	220 ohm	1/6W PJ
R3030	Carbon Film Res.	2.7k ohm	1/6W PJ
R3031	Carbon Film Res.	680 ohm	1/6W PJ
R3032	Carbon Film Res.	1.2k ohm	1/6W PJ
R3033	Carbon Film Res.	47k ohm	1/6W PJ
R3034	Carbon Film Res.	47k ohm	1/6W PJ

For Service Manuals Contact
MAURITRON TECHNICAL SERVICES
 8 Cherry Tree Rd, Chinnor
 Oxon OX9 4QY
 Tel: 01844-351694 Fax: 01844-352554
 Email: enquiries@mauritron.co.uk

PARTS LIST

LPF UNIT		PCB with Components		Printed Circuit Board	
CP1274001		F29480000			
D4001	G2090408	Diode	1SS270		
D4002	G2090408	Diode	1SS270		
D4003	G2090244	Diode	1SS106		
D4004	Q9000375	Surge Absorber	DSP201M-S00B		
R4002	J02225270	Carbon Film Res.	27 Ohm	1/6W	UJ
R4003	J02225270	Carbon Film Res.	27 Ohm	1/6W	UJ
C4001	K30275102	Mica Cap.	1000pF	500V	SL
C4002	K00275680	Ceramic Cap.	68pF	500V	SL
C4003	K00276161	Ceramic Cap.	160pF	500V	SL
C4004	K30275122	Mica Cap.	1200pF	500V	SL
C4005	K30275681	Mica Cap.	680pF	500V	SL
C4006	K30275361	Mica Cap.	560pF	500V	SL
C4007	K30275321	Mica Cap.	820pF	500V	SL
C4008	K00275180	Ceramic Cap.	18pF	500V	SL
C4009	K30275561	Mica Cap.	560pF	500V	SL
C4010	K00275241	Ceramic Cap.	240pF	500V	SL
C4011	K30275122	Mica Cap.	1200pF	500V	SL
C4012	K00275820	Ceramic Cap.	82pF	500V	SL
C4013	K30275621	Mica Cap.	620pF	500V	SL
C4014	K00275241	Ceramic Cap.	240pF	500V	SL
C4015	K00275111	Ceramic Cap.	110pF	500V	SL
C4016	K30275681	Mica Cap.	680pF	500V	SL
C4017	K00275360	Ceramic Cap.	36pF	500V	SL
C4018	K00275151	Ceramic Cap.	150pF	500V	SL
C4019	K00275221	Ceramic Cap.	220pF	500V	SL
C4020	K00276161	Ceramic Cap.	160pF	500V	SL
C4021	K00275430	Ceramic Cap.	43pF	500V	SL
C4022	K30275301	Mica Cap.	300pF	500V	SL
C4023	K00275111	Ceramic Cap.	110pF	500V	SL
C4024	K00275111	Ceramic Cap.	110pF	500V	SL
C4025	K00275101	Ceramic Cap.	100pF	500V	SL
C4026	K00275430	Ceramic Cap.	43pF	500V	SL
C4027	K00275151	Ceramic Cap.	150pF	500V	SL
C4028	K00275820	Ceramic Cap.	82pF	500V	SL
C4029	K00275120	Ceramic Cap.	12pF	500V	SL
C4030	K00275111	Ceramic Cap.	110pF	500V	SL
C4031	K00275820	Ceramic Cap.	82pF	500V	SL
C4032	K00275330	Ceramic Cap.	33pF	500V	SL
C4033	K00276161	Ceramic Cap.	160pF	500V	SL
C4034	K00275120	Ceramic Cap.	12pF	500V	SL
C4035	K00275910	Ceramic Cap.	91pF	500V	SL
C4036	K00175221	Ceramic Cap.	220pF	50V	SL
C4037	K00175221	Ceramic Cap.	220pF	50V	SL
C4038	K00275100	Ceramic Cap.	10pF	500V	SL
C4039	K13179009	Ceramic Cap.	0.047uF	50V	F
C4040	K13179009	Ceramic Cap.	0.047uF	50V	F
C4041	K13179009	Ceramic Cap.	0.047uF	50V	F
C4042	K13179009	Ceramic Cap.	0.047uF	50V	F
C4043	K13179009	Ceramic Cap.	0.047uF	50V	F
C4044	K13179009	Ceramic Cap.	0.047uF	50V	F
C4045	K13179009	Ceramic Cap.	0.047uF	50V	F
C4046	K13179009	Ceramic Cap.	0.047uF	50V	F
C4047	K13179009	Ceramic Cap.	0.047uF	50V	F
C4048	K13179009	Ceramic Cap.	0.047uF	50V	F

S3013	N5090010	Switch	KEG10904
S3014	N5090010	Switch	KEG10904
S3015	N4090081	Switch	SPH121C16
S3016	N4090081	Switch	SPH121C16
S3017	N4090081	Switch	SPH121C16
S3018	N4090081	Switch	SPH121C16
S3019	N6090061	Switch	SSJ-012M
J3002	P0090203	Connector	S02B-XH-A
J3003	P0090638	Connector	SC25-0.5WL
J3004	P0090637	Connector	SC25-0.3WL
J3005	P0090639	Connector	SC25-0.6WL
PL3001	Q1000010	Lamp	BQ041-22803A
PL3002	Q1000010	Lamp	BQ041-22803A
PL3003	Q1000010	Lamp	BQ041-22803A
BAT 3001	Q9000106	Lithium Battery	CR2025-HM1
	Q9000192	Thermal conductor	30F-TO-220
R0102810		Nut Board	
R3124170B		Light Reflector	
R0124180		Heatsing Plate	
R7125120A		Filter	
R7125420		Sponge	
R7125440		Sponge	
R7126160		Sponge Rubber	
R7126480		Mylar Film	
R7129620		Mylar Film	
T9205611		Wire Assy	JPI-P1
T9205612		Wire Assy	JP2-P2
T9205613		Wire Assy	JP3-P3
T9205626		Wire Assy	JP4-P4
T9205636		Wire Assy	JP5

PARTS LIST

100W-PA UNIT		PCB with Components		Printed Circuit Board	
C50025001		F2947000			
C4049	K13179009	Ceramic Cap.	0.047uF	50V	F
C4050	K13179009	Ceramic Cap.	0.047uF	50V	F
C4051	K13179009	Ceramic Cap.	0.047uF	50V	F
C4052	K13179009	Ceramic Cap.	0.047uF	50V	F
C4053	K13179009	Ceramic Cap.	0.047uF	50V	F
TC4001	K91000013	Variable Cap.	20pF		
L4001	L0021405	Coil	3.77uH		
L4002	L0021406	Coil	2.94uH		
L4003	L0020615	Coil	1.90uH		
L4004	L0021433	Coil	2.40uH		
L4005	L0020617	Coil	1.10uH		
L4006	L0020618	Coil	1.32uH		
L4007	L0021407	Coil	0.62uH		
L4008	L0021408	Coil	0.46uH		
L4009	L0021855	Coil			
L4010	L0021856	Coil			
L4011	L0021857	Coil			
L4012	L0021858	Coil			
L4013	L0021859	Coil			
L4014	L1190090	RFC	1mH		
L4015	L1190090	RFC	1mH		
RL4001	M1190045	Relay	AG2013(DC12V)		
RL4002	M1190045	Relay	AG2013(DC12V)		
RL4003	M1190045	Relay	AG2013(DC12V)		
RL4004	M1190045	Relay	AG2013(DC12V)		
RL4005	M1190045	Relay	AG2013(DC12V)		
RL4006	M1190045	Relay	AG2013(DC12V)		
RL4007	M1190045	Relay	AG2013(DC12V)		
RL4008	M1190045	Relay	AG2013(DC12V)		
RL4009	M1190045	Relay	AG2013(DC12V)		
RL4010	M1190045	Relay	AG2013(DC12V)		
RL4011	M1190045	Relay	AG2013(DC12V)		
RL4012	M1190045	Relay	AG2013(DC12V)		
RL4013	M1190078	Relay	AG2017(DC9V)		
T9317815		Wire Assy	P4002		
T9205615		Wire Assy	P4003		
T9317816		Wire Assy	P4004		
T9205614A		Wire Assy	JP4001 (P4001)		

For Service Manuals Contact
MAURITRON TECHNICAL SERVICES
 8 Cherry Tree Rd, Chinnor
 Oxon OX9 4QY
 Tel:- 01844-351694 Fax:- 01844-352554
 Email:- enquires@mauritron.co.uk

J5001 J5002 J5003 J5004 J5005 J5006 J5007	P1090255 P1090255 P0090622 P0090621 R0100970 R0100970 P0090621 R0103760 Q9000192 Q9000284	Connector Connector Connector Terminal Terminal Connector TR Heatsink Thermal conductor Insulator
<p>For Service Manuals Contact MAURITRON TECHNICAL SERVICES 8 Cherry Tree Rd, Chinnor Oxon OX9 4QY Tel:- 01844-351694 Fax:- 01844-352554 Email:- enquiries@mauritron.co.uk</p>		

VR5001	J51745331	POT.	33 ohm	B
C5001	K10179024	Ceramic Cap.	0.01uF	B
C5002	K10179024	Ceramic Cap.	0.01uF	50V
C5003	K10179024	Ceramic Cap.	0.01uF	50V
C5004	K13179009	Ceramic Cap.	0.047uF	50V
C5005	K13179008	Ceramic Cap.	0.01uF	50V
C5006	K40129004	Al Electro Cap.	10uF	16V
C5007	K13179009	Ceramic Cap.	0.047uF	50V
C5009	K13179008	Ceramic Cap.	0.01uF	50V
C5010	K00175471	Ceramic Cap.	470uF	50V
C5011	K13179009	Ceramic Cap.	0.047uF	50V
C5012	K13179009	Ceramic Cap.	0.047uF	50V
C5013	K19149025	Ceramic Cap.	0.1uF	25V
C5014	K19149021	Ceramic Cap.	0.047uF	25V
C5015	K13179009	Ceramic Cap.	0.047uF	50V
C5016	K30279093	Mica Cap.	1000pF	500V
C5017	K10276682	Ceramic Cap.	6800pF	500V
C5018	K10276682	Ceramic Cap.	6800pF	500V
C5019	K13179009	Ceramic Cap.	0.047uF	50V
C5020	K50177683	Film Cap.	0.068uF	50V
C5021	K13179009	Ceramic Cap.	0.047uF	50V
C5022	K50177683	Film Cap.	0.068uF	50V
C5023	K30279090	Mica Cap.	560pF	500V
C5024	K30279090	Mica Cap.	560pF	500V
C5025	K30279092	Mica Cap.	750pF	500V
C5026	K30279091	Mica Cap.	620pF	500V
C5027	K13179009	Ceramic Cap.	0.047uF	50V
C5028	K40129004	Al Electro Cap.	10uF	16V
C5029	K13179009	Ceramic Cap.	0.047uF	50V
C5030	K40129004	Al Electro Cap.	10uF	16V
C5031	K13179009	Ceramic Cap.	0.047uF	50V
C5032	K40129004	Al Electro Cap.	10uF	16V
C5033	K40129021	Al Electro Cap.	1000uF	16V
C5034	K19149025	Ceramic Cap.	0.1uF	25V
C5035	K40129004	Al Electro Cap.	10uF	16V
C5036	K13179009	Ceramic Cap.	0.047uF	50V
C5037	K13179009	Ceramic Cap.	0.047uF	50V
C5038	K40129004	Al Electro Cap.	10uF	16V
C5039	K40129013	Al Electro Cap.	1uF	16V
C5040	K40129013	Al Electro Cap.	1uF	16V
C5041	K13179009	Ceramic Cap.	0.047uF	50V
C5042	K13179009	Ceramic Cap.	0.047uF	50V
C5043	K13179009	Ceramic Cap.	0.047uF	50V
C5044	K13179008	Ceramic Cap.	0.01uF	50V
C5045	K13179008	Ceramic Cap.	0.01uF	50V
C5046	K13179008	Ceramic Cap.	0.01uF	50V
C5047	K13179008	Ceramic Cap.	0.01uF	50V
C5048	K30275361	Mica Cap.	360pF	500V
L5001	L1190196	RFC	1.2uH	
L5002	L1020015	RFC		
L5003	L1020015	RFC		
L5004	L0021432	Coil	41.0uH	
T5001	L0020788A	Coil		
T5002	L0020833A	Coil		
T5003	L0021854	Coil		
T5004	L0020404	Coil		
RL5001	M1190055	Relay	AR49032 (DC12V)	

PARTS LIST

PHONE JACK UNIT	
C029433AA	PCB with Components
F2943103A	Printed Circuit Board
J9001	PI090351
	Connector
	CW-Assy
ACCESSORIES	
	DC-Cord
	Fuse(100w Type)
	20A

For Service Manuals Contact
MAURITRON TECHNICAL SERVICES
 8 Cherry Tree Rd, Chinnor
 Oxon OX9 4QY
 Tel: 01844-351894 Fax: 01844-352554
 Email: enquiries@mauritron.co.uk

FILTER UNIT					
CF1248001	PCB with Components				
F2944101	Printed Circuit Board				
D8201	G2090118	Diode	1SS97		
D8202	G2090118	Diode	1SS97		
D8203	G2090118	Diode	1SS97		
D8204	G2090118	Diode	1SS97		
D8205	G2060004	Diode	1SS270TJ		
D8206	G2060004	Diode	1SS270TJ		
D8207	G2090118	Diode	1SS97		
D8208	G2060004	Diode	1SS270TJ		
D8209	G2060004	Diode	1SS270TJ		
D8210	G2090118	Diode	1SS97		
D8211	G2090118	Diode	1SS97		
D8212	G2090118	Diode	1SS270TJ		
D8213	G2060004	Diode	1SS270TJ		
D8214	G2060004	Diode	1SS270TJ		
D8215	G2090408	Diode	1SS270TJ		
D8216	G2090408	Diode	1SS270TJ		
D8217	G2090118	Diode	1SS97		
XF8201	H1102128	Crystal Filter	XF8.2M-242-02		
XF8202	H1102129	Crystal Filter	XF8.2M-501-01		
R8201	J01225471	Carbon Film Res.	470 ohm	PJ	
R8202	J01225221	Carbon Film Res.	220 ohm	PJ	
R8203	J01225101	Carbon Film Res.	100 ohm	PJ	
R8204	J01225470	Carbon Film Res.	47 ohm	PJ	
R8205	J01225151	Carbon Film Res.	150 ohm	PJ	
R8206	J01225221	Carbon Film Res.	220 ohm	PJ	
R8207	J01225391	Carbon Film Res.	390 ohm	PJ	
R8208	J01225121	Carbon Film Res.	120 ohm	PJ	
R8209	J01225102	Carbon Film Res.	1k ohm	PJ	
R8210	J01225121	Carbon Film Res.	120 ohm	PJ	
R8211	J01225101	Carbon Film Res.	100 ohm	PJ	
R8212	J01225471	Carbon Film Res.	470 ohm	PJ	
R8213	J01225010	Carbon Film Res.	1 ohm	PJ	
R8214	J01225010	Carbon Film Res.	1 ohm	PJ	
R8215	J01225271	Carbon Film Res.	270 ohm	PJ	
C8201	K00173100	Ceramic Cap.	10pF	SL	50V
C8202	K28129001	Ceramic Cap.	0.01uF	Y	16V
C8203	K28129001	Ceramic Cap.	0.01uF	Y	16V
C8204	K00173100	Ceramic Cap.	10pF	SL	50V
C8205	K28129001	Ceramic Cap.	0.01uF	Y	16V
C8206	K28129001	Ceramic Cap.	0.01uF	Y	16V
C8208	K28129001	Ceramic Cap.	0.01uF	Y	16V
C8209	K28129001	Ceramic Cap.	0.01uF	Y	16V
C8211	K28129001	Ceramic Cap.	0.01uF	Y	16V
L8201	L1190220	RFC	150uH		
L8202	L1190220	RFC	150uH		
L8203	L1190220	RFC	150uH		
J8201	P0090352	Connector			
J8202	P0090390	Connector			

PARTS LIST

FM UNIT		Printed Circuit Board	
F2945101		PCB with Components	
Q8002	G1090145	IC	MC3357P
Q8003	G2090749	IC	C5223P
Q8004	G3327127G	Transistor	25C2712GR-TE85R
Q8005	G3327127G	Transistor	25C2712GR-TE85R
Q8006	G3070002	Transistor	DTC114-EK
Q8007	G3070010	Transistor	DTC143-EK
D8002	G2090408	Diode	1S5270
D8003	G2090408	Diode	1S5270
D8005	G2090180	Diode	FC52M-5
D8006	G9090007	Diode	MV-12
D8008	G2090408	Diode	1S5270
TH8001	G9090016	Thermistor	112252-2
X8001	H0102855	Crystal	HC-49u/3P 8.6708MHZ
X8002	H0102854	Crystal	HC-49u/3P 8.2158MHZ
CF8001	H3900387	Ceramic Filter	LF-H8S
CD8001	H7900180	Ceramic Disc.	CDB455C7
R8006	J24205222	Chip Res.	2.2k ohm 1/10w
R8007	J24205222	Chip Res.	2.2k ohm 1/10w
R8008	J24205473	Chip Res.	47k ohm 1/10w
R8009	J24205152	Chip Res.	1.5k ohm 1/10w
R8010	J24205332	Chip Res.	3.3k ohm 1/10w
R8011	J24205333	Chip Res.	33k ohm 1/10w
R8013	J24205153	Chip Res.	15k ohm 1/10w
R8014	J24205152	Chip Res.	1.5k ohm 1/10w
R8015	J24205334	Chip Res.	330k ohm 1/10w
R8016	J24205102	Chip Res.	1k ohm 1/10w
R8017	J24205472	Chip Res.	4.7k ohm 1/10w
R8019	J24205821	Chip Res.	820 ohm 1/10w
R8021	J24205101	Chip Res.	100 ohm 1/10w
R8022	J24205154	Chip Res.	150k ohm 1/10w
R8023	J24205472	Chip Res.	4.7k ohm 1/10w
R8024	J24205335	Chip Res.	3.3M ohm 1/10w
R8025	J24205332	Chip Res.	3.3k ohm 1/10w
R8026	J24205472	Chip Res.	4.7k ohm 1/10w
R8027	J24205392	Chip Res.	3.9k ohm 1/10w
R8028	J24205123	Chip Res.	12k ohm 1/10w
R8029	J24205123	Chip Res.	12k ohm 1/10w
R8030	J24205105	Chip Res.	1M ohm 1/10w
R8031	J24205223	Chip Res.	22k ohm 1/10w
R8032	J24205102	Chip Res.	1k ohm 1/10w
R8033	J24205562	Chip Res.	5.6k ohm 1/10w
R8034	J24205104	Chip Res.	100k ohm 1/10w
R8035	J24205223	Chip Res.	22k ohm 1/10w
R8036	J24205153	Chip Res.	15k ohm 1/10w
R8037	J24205101	Chip Res.	100 ohm 1/10w
R8038	J24205471	Chip Res.	470 ohm 1/10w
R8039	J24205223	Chip Res.	22k ohm 1/10w
R8040	J24205472	Chip Res.	4.7k ohm 1/10w
R8041	J24205101	Chip Res.	100 ohm 1/10w
R8042	J24205102	Chip Res.	1k ohm 1/10w

R8043	J01225824	Chip Res.	820k ohm	1/10w	CH
VR8001	J51745222	POT.	2.2k		CH
VR8002	J21745103	POT.	10k		CH
VR8003	J51745472	POT.	4.7k		CH
C8003	K22170235	Chip Cap.	100pF	50V	
C8004	K22170227	Chip Cap.	47pF	50V	
C8005	K22170237	Chip Cap.	120pF	50V	
C8006	K22141809	Chip Cap.	0.1uF	50V	
C8007	K22141809	Chip Cap.	0.1uF	50V	
C8008	K22170237	Chip Cap.	120pF	50V	
C8010	K22170237	Al Electro Cap.	1uF	50V	
C8011	K19149001	Ceramic Cap.	0.001uF	50V	
C8012	X19149001	Chip Cap.	0.001uF	50V	
C8013	K19149025	Chip Cap.	0.1uF	50V	
C8014	K22171008	Chip Cap.	0.047uF	50V	
C8015	K70147155	Tantalum Cap.	1.5uF	50V	
C8016	K22170817	Chip Cap.	0.01uF	50V	
C8017	K22170805	Chip Cap.	0.001uF	50V	
C8018	K40149025	Al Electro Cap.	22uF	25V	
C8019	K50177472	Mica Cap.	0.0047uF	50V	
C8020	K40179013	Al Electro Cap.	1uF	50V	
C8021	K50177682	Film Cap.	0.0068uF	50V	
C8022	K40149025	Al Electro Cap.	22uF	25V	
C8023	K50177332	Film Cap.	0.0033uF	50V	
C8024	K40179013	Al Electro Cap.	1uF	50V	
C8025	K22170805	Chip Cap.	0.001uF	50V	
C8026	K22170347	Chip Cap.	330pF	50V	
C8027	K22170347	Chip Cap.	330pF	50V	
C8028	K22170817	Chip Cap.	0.01uF	50V	
C8029	K22170323	Chip Cap.	33pF	50V	
C8031	K22170817	Chip Cap.	0.01uF	50V	
C8032	K22170817	Chip Cap.	0.01uF	50V	
C8033	K22170817	Chip Cap.	0.01uF	50V	
C8035	K22170817	Chip Cap.	0.01uF	50V	
C8036	K22170817	Chip Cap.	0.01uF	50V	
T8001	L0021863	Coil	SO-7008	8.2158MHZ	
T8002	L0021199	Coil	1212-4043A	8.20MHZ	
L8001	L1190189	RFC	LAL03NA102K	1mH	
J8001	P1090595	Connector	11P-SHVQ		
Q6100017	Q6100017	Jumper C	0.6-7.5		
Q6100002	Q6100002	Jumper C	0.6-10.0		

NOTE

For Service Manuals Contact
MAURITRON TECHNICAL SERVICES
8 Cherry Tree Rd, Chinnor
Oxon OX9 4QY
Tel: 01844-351694 Fax: 01844-352554
Email: enquires@mauritron.co.uk